

FlexElite iW

Date: _____
Type: _____
Firm Name: _____
Project: _____

**20 Nodes, Black Node/Cable,
500 mm (1.6 ft) On-Center Node
Spacing**

Exterior bright and beautiful flexible direct view luminaire with tunable white light

FlexElite is the brightest and most flexible member of the Flex family. It includes a redesign of all major elements, from its form factor to internal electronics to mechanical design. We created FlexElite to meet the challenges posed by large, unconventional buildings and structures. At its core, you'll find an innovative modular design that lets you create the exact number and configuration of nodes that you need for your design. FlexElite's sections and jumper cables click together quickly and easily, allowing unequalled customization. Longer run lengths and node spacing let you take on larger challenges than possible in the past. FlexElite iW has 4 channels of white light that can be combined to offer variable color temperatures. With our Chromasync technology, you can also use a single channel to provide Essential White light at the same brightness as in 4-channel mode.



- **Modular Design**—FlexElite's advanced technology frees you from the limitations posed by static numbers of nodes on flexible cables—enabling longer run lengths and node spacing. You can choose sections with the number of nodes you need. Plus, multiple jumper cable lengths let you get the node spacing you need for your design—achieving the right resolution. FlexElite can deliver run lengths of up to 1,000 feet per run, with variable distances between nodes. With FlexElite, you can take on a wide range of outdoor applications, from arenas to office buildings to bridges.
- **Brighter Output**—FlexElite is the brightest Flex luminaire available. At its brightest, FlexElite IntelliHue achieves 150 lumens per node. Brighter output lets you take on larger structures and create ambitious, large-scale designs that get noticed. And our lumen measurement complies with IES LM-79-08 testing procedures for consistency.
- **Four Channels of White Light**—FlexElite luminaires are natively designed as four-channel luminaires. Choose iW for white light in temperatures of 2200 K, 3000 K, 4000 K, and 6500 K, tunable to anywhere in between. FlexElite includes our proprietary Chromasync technology to enable maximum lumen output at whatever temperature of white light you choose.
- **Simple Installation**—Push-and-click connectors ensure reliable connections, while intuitive mounting options make it easy for installers to mount FlexElite on any structure.
- **Proven Reliability**—FlexElite is designed to be extremely reliable, year after year. Thanks to smart design, extensive testing, and years of experience, FlexElite can handle extreme conditions, humidity, heat, cold, and ice—delivering reliable performance.
- **Complete Solution**—An advanced, reliable luminaire is a critical part of your direct-view lighting solution, but it's not the only element that matters. That's why Color Kinetics offers a full range of complementary solutions—including power/data supplies, controllers, and much more. All designed and optimized to ensure seamless integration and years of trouble-free operation. For example, we designed our PDS-400 48V CA4 power/data supply specifically for FlexElite. And FlexElite integrates with ActiveSite, our remote monitoring solution.

For detailed product information, please refer to the FlexElite iW Product Guide at www.colorkinetics.com/global/products/intelliwhite/flexelite-iw

Specifications

Due to continuous improvements and innovations, specifications may change without notice.

Output

Viewing Angle	140°
Lumens Per Node (all channels full on) [†]	142
Lumens @ 2200 K*	99
Lumens @ 3000 K*	131
Lumens @ 4000 K*	139
Lumens @ 6500 K*	149
Lumens @ 2200 K to 3000 K*	121
Lumens @ 3000 K to 4000 K*	141
Lumens @ 4000 K to 6500 K*	150
Luminance Per Node	104,842 cd/m ²
On-Axis Candela per node	53
Efficacy (lm/W) per node all channels full on	59.1
CRI All Channels Full On	95.8
LED Channels	2200 K to 6500 K

Electrical

Input Voltage	48 VDC via PDS-400 48V CA4
Power Consumption (Maximum per node at full output, steady state)	2.5 W

Control

Interface	PDS-400 48V CA4
-----------	-----------------

Control System

Color Kinetics full range of controllers, including Light System Manager, Video System Manager Pro, iPlayer 3, Antumbra iColor Keypad, and ColorDial Pro, or third-party controllers

Remote Monitoring & Management	ActiveSite Ready, works with Interact Landmark
--------------------------------	--

Lumen Maintenance

Threshold [§]	Ambient Temperature	Reported [¶]	Calculated [¶]
L ₉₀	25 °C	59,484	59,484
	50 °C	59,484	59,484
L ₈₀	25 °C	> 60,000	> 100,000
	50 °C	> 60,000	> 100,000
L ₇₀	25 °C	> 60,000	> 100,000
	50 °C	> 60,000	> 100,000
L ₅₀	25 °C	> 60,000	> 100,000
	50 °C	> 60,000	> 100,000

* Correlated color temperature (CCT) complies with ANSI C78.377-2008 for the chromaticity of solid state lighting products.

† Lumen output measurements comply with IES LM-79-08 testing procedures.

§ L_{xx} = xx% lumen maintenance (when light output drops below xx% of initial output). All values are given at B10, or the median value where 90% of the LED population is better than the reported or calculated lumen maintenance measurement.

¶ Lumen maintenance figures are based on lifetime prediction graphs supplied by LED source manufacturers. Whenever possible, figures use measurements that comply with IES LM-80-08 testing procedures. In accordance with TM-21-11, Reported values represent the interpolated value based on six times the LM-80-08 total test duration (in hours). Calculated values represent time durations that exceed six times the total test duration.

‡ Due to voltage/power loss in leader and jumper cables, most installations will not be able to install the full 160 nodes per PDS. Please consult Color Kinetics for maximum run length calculations for your projects.

Physical

Dimensions (Height x Width x Depth)	60 x 97.81 x 27.66 mm (2.36 x 3.85 x 1.09 in)
Weight	4.34 kg (9.57 lb)
Housing Material	Black PBT plastic and powder-coated aluminium
Lens	Tempered glass
Luminaire Connections	Integrated watertight 5-pin connector

Temperature Ranges

-40 to 50 °C (-40 to 122 °F) Operating
> 0 °C (> 32 °F) Handling
-20 to 50 °C (-4 to 122 °F) Startup
-40 to 80 °C (-40 to 176 °F) Storage

Humidity	0 to 95%, non-condensing
----------	--------------------------

Maximum Luminaires Per Power/Data Supply^{‡‡}

PDS-400 48V CA4: 160 nodes

Certification and Safety

Approbation	UL/cUL, FCC Class A, CE
Environment	Dry/Damp/Wet Location, IP66



Dimensions

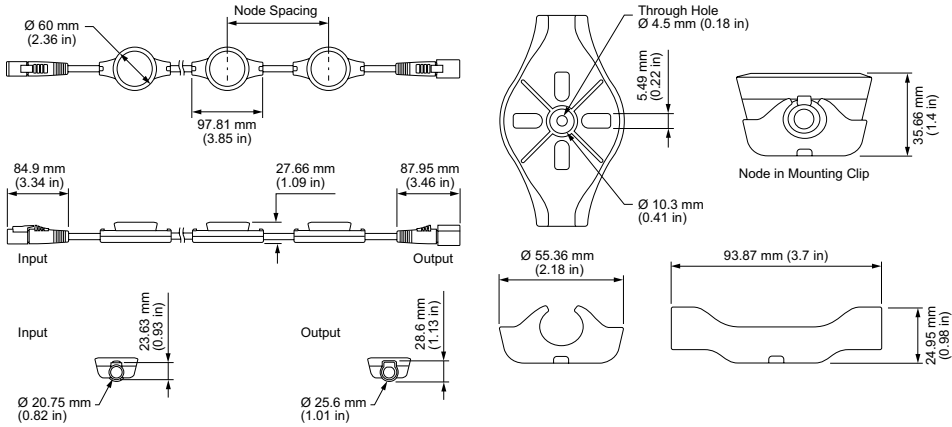

Photometrics, all channels full on

Photometric data is based on test results from an independent NIST traceable testing lab. IES data is available at www.colorkinetics.com/support/ies.

Viewing Angle	140°
LEDs	All channels full on
Lumens Per Node (all channels full on)	142
Efficacy (lm/W) per node all channels full on	59.1

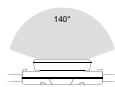

Polar Candela Distribution

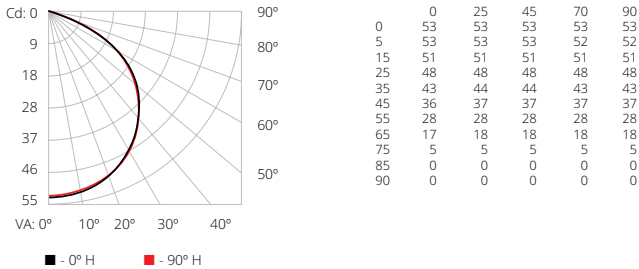

Zonal Lumen

Zone	Lumens	% Luminaire
0-30	41.3	29.0%
0-40	68.0	47.8%
0-60	120.6	84.7%
60-90	21.8	15.3%
70-100	5.2	3.7%
90-120	0.0	0.0%
0-90	142.4	100.0%
90-180	0.0	0.0%
0-180	142.4	100.0%

For lux multiply fc by 10.7

Illuminance at Distance

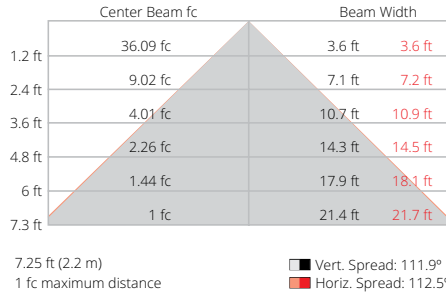

Coefficients of Utilization - Zonal Cavity Method

RCC %:	Effective Floor Cavity Reflectance: 20%																												
	80				70				50				30				10				0								
RW %:	70	50	30	0	70	50	30	0	50	30	20	50	30	20	50	30	20	50	30	20	50	30	20	50	30	20	50	30	20
0	1.19	1.19	1.19	1.19	1.16	1.16	1.16	1	1.11	1.11	1.11	1.06	1.06	1.06	1.02	1.02	1.02	1											
1	1.1	1.06	1.02	0.99	1.07	1.04	1	0.87	0.99	0.96	0.94	0.95	0.93	0.91	0.92	0.9	0.88	0.86											
2	1.01	0.93	0.87	0.81	0.98	0.91	0.85	0.74	0.88	0.83	0.79	0.84	0.8	0.77	0.81	0.78	0.75	0.73											
3	0.92	0.82	0.74	0.68	0.9	0.8	0.73	0.64	0.77	0.71	0.66	0.75	0.7	0.65	0.72	0.68	0.64	0.62											
4	0.84	0.73	0.64	0.58	0.82	0.71	0.64	0.55	0.69	0.62	0.57	0.67	0.61	0.56	0.65	0.59	0.55	0.53											
5	0.77	0.65	0.56	0.5	0.75	0.64	0.56	0.48	0.62	0.55	0.49	0.6	0.54	0.49	0.58	0.53	0.48	0.46											
6	0.72	0.59	0.5	0.44	0.7	0.58	0.49	0.42	0.56	0.48	0.43	0.54	0.48	0.43	0.53	0.47	0.42	0.4											
7	0.66	0.53	0.44	0.38	0.65	0.52	0.44	0.37	0.51	0.43	0.38	0.49	0.43	0.38	0.48	0.42	0.37	0.36											
8	0.62	0.48	0.4	0.34	0.6	0.48	0.4	0.33	0.46	0.39	0.34	0.45	0.39	0.34	0.44	0.38	0.34	0.32											
9	0.58	0.44	0.36	0.31	0.56	0.44	0.36	0.3	0.43	0.36	0.31	0.42	0.35	0.3	0.41	0.35	0.3	0.28											
10	0.54	0.41	0.33	0.28	0.53	0.4	0.33	0.27	0.39	0.32	0.28	0.38	0.32	0.28	0.38	0.32	0.27	0.26											

Luminaire and Accessories

Use Item Number when ordering in North America

Luminaire	Item Number	Item 12NC
FlexElite iW 20 Nodes, Black Node/Cable, 500 mm (1.6 ft) On-Center Node Spacing	501-000017-34	912400136978
Accessories		
FlexElite Leader Cable, 7.5 m (25 ft), Black, UL/CE	108-000085-00	912400136420
FlexElite Leader Cable, 15 m (50 ft), Black, UL/CE	108-000085-01	912400136421
FlexElite Leader Cable, 30 m (100 ft), Black, UL/CE	108-000085-02	912400136422
FlexElite Leader Cable, 60 m (200 ft), Black, UL/CE	108-000085-03	912400136423
FlexElite Jumper Cable, 305 mm (1 ft), Black, UL/CE	108-000085-04	912400136424
FlexElite Jumper Cable, 500 mm (1.7 ft), Black, UL/CE	108-000085-05	912400136425
FlexElite Jumper Cable, 610 mm (2 ft), Black, UL/CE	108-000085-06	912400136426
FlexElite Jumper Cable, 1 m (3.3 ft), Black, UL/CE	108-000085-07	912400136427
FlexElite Jumper Cable, 1.5 m (5 ft), Black, UL/CE	108-000085-08	912400136428
FlexElite Jumper Cable, 2 m (6.6 ft), Black, UL/CE	108-000085-09	912400136429
FlexElite Jumper Cable, 3 m (10 ft), Black, UL/CE	108-000085-10	912400136430
FlexElite Dome Lens, Black, 10 pieces	120-000204-02	912400136444
FlexElite Single Node Mounting Clip, Black, 10 pieces	120-000204-00	912400136442
Power Supplies		
PDS-400 48V CA4, UL	109-000035-00	912400135914
PDS-400 48V CA4, CE	109-000035-01	912400136495



© 2019 Signify Holding. All rights reserved. Specifications are subject to change without notice. No representation or warranty as to the accuracy or completeness of the information included herein is given and any liability for any action in reliance thereon is disclaimed.

Color Kinetics
www.colorkinetics.com/global/products/intelliwhite/flexelite-iw