

## FEATURES

LED spot & Flood light for track, T5 series.

**Housing:** The design of the outer case and the internal heat sink combination to induce forced convection transfer for excellent heat dissipation.

**Reflector:** Black NGR finish.

**Mounting Track:** For the three-circuit track for control system such as 1–10V.



Product ordering number **18513W-827C-020-040**  
**18513W-830C-020-040**  
**18513W-840C-020-040**

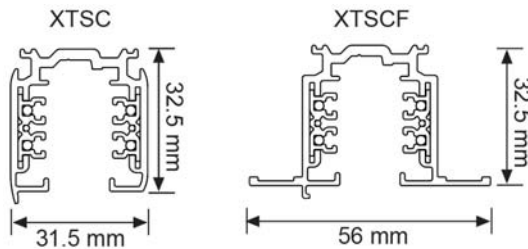

## SPECIFICATIONS

INDEX		DATA
DIMENSION	mm	W90 X L242 X H223
WEIGHT	Kg	1.85
OPERATING VOLTAGE	V	AC 100~240V
POWER CONSUMPTION	W	20 (with power supply unit)
COLOR TEMPERATURE	K	2700 / 3000 / 4000
LUMINOUS FLUX	lm	2,250
LOR	-	0.76
COLOR RENDERING INDEX	Ra	Over 80
BEAM ANGLE	°	40
IP RATING	-	20
STORAGE HUMIDITY	%	20% ~ 70%
STORAGE TEMPERATURE	°C	-40°C ~ +50°C
OPERATING TEMPERATURE	°C	-20°C ~ +50°C

## PHOTOMETRIC DATA

40°		
m	Ø(m)	lux(center/side)
1	0.73	3343/1578
2	1.46	836/394
3	2.19	371/175

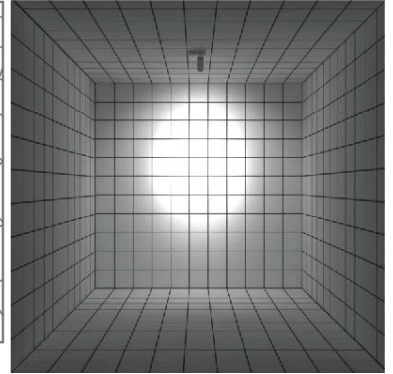
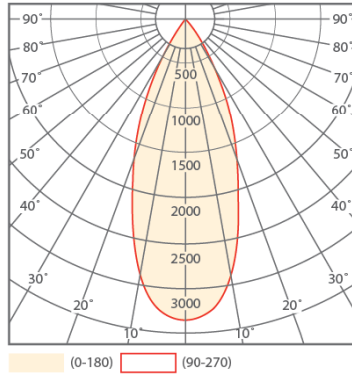

## DRAWING DATA

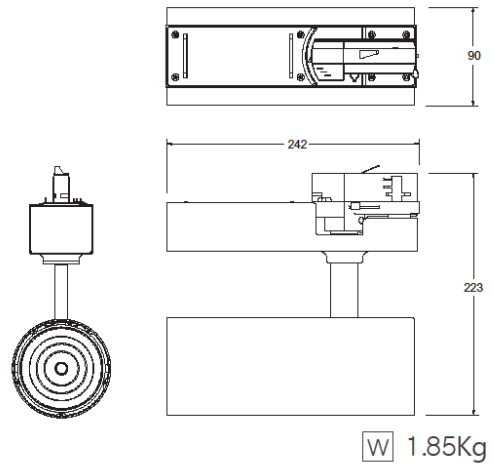

## INSTALLATION INSTRUCTIONS

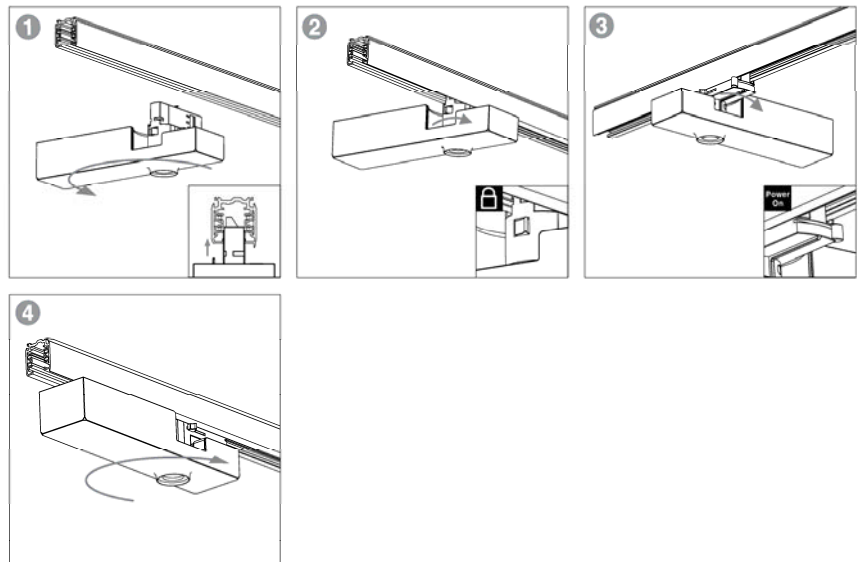

## NOTES

**Attention** Read carefully before installing.  
 The safety of this fixture is guaranteed only if you comply with these instructions. Save these instructions for future use.  
 The operating temperature is between -20°C and +50°C.

## INSTALLATION INSTRUCTIONS (Reflector)

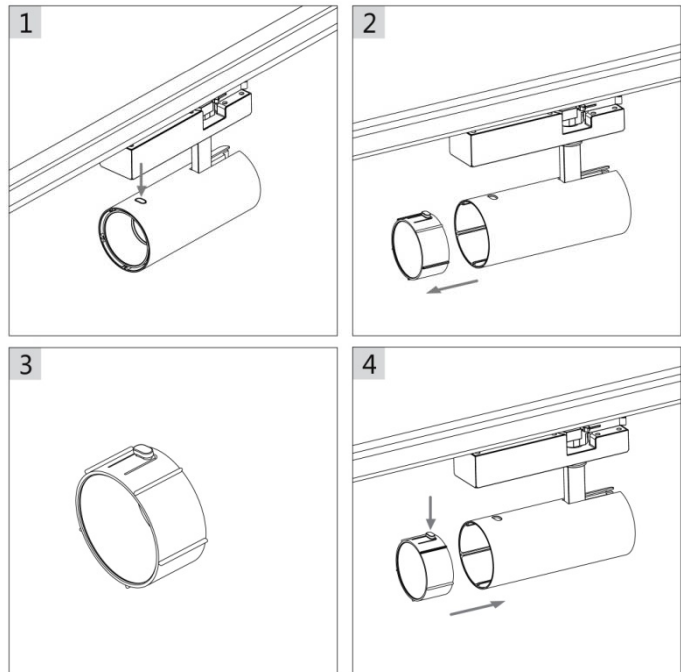

## NOTES

**Attention** Read carefully before installing.

The safety of this fixture is guaranteed only if you comply with these instructions. Save these instructions for future use.

The operating temperature is between -20°C and +50°C.