

FEATURES

LED spot & Flood light for track, T5 series.

Housing: The design of the outer case and the internal heat sink combination to induce forced convection transfer for excellent heat dissipation.

Reflector: Black NGR finish.

Mounting Track: For the three-circuit track for control system such as 1–10V.



Product ordering number **18513D-827C-020-040**
18513D-830C-020-040
18513D-840C-020-040

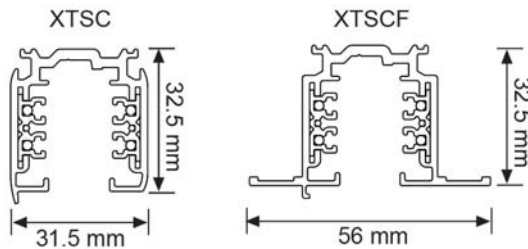

SPECIFICATIONS

INDEX		DATA
DIMENSION	mm	W90 X L242 X H223
WEIGHT	Kg	1.85
OPERATING VOLTAGE	V	AC 100~240V
POWER CONSUMPTION	W	20 (with power supply unit)
COLOR TEMPERATURE	K	2700 / 3000 / 4000
LUMINOUS FLUX	lm	2,250
LOR	-	0.76
COLOR RENDERING INDEX	Ra	Over 80
BEAM ANGLE	°	40
IP RATING	-	20
STORAGE HUMIDITY	%	20% ~ 70%
STORAGE TEMPERATURE	°C	-40°C ~ +50°C
OPERATING TEMPERATURE	°C	-20°C ~ +50°C

PHOTOMETRIC DATA

40°		
m	Ø(m)	lux(center/side)
1	0.73	3343/1578
2	1.46	836/394
3	2.19	371/175

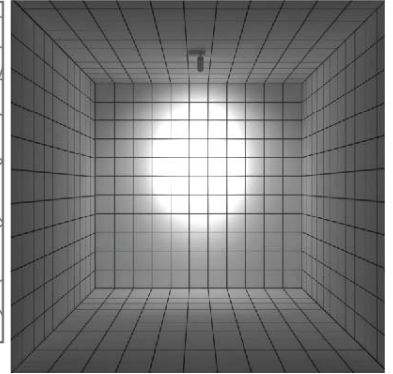
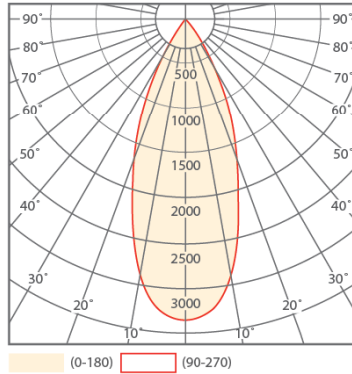

DRAWING DATA

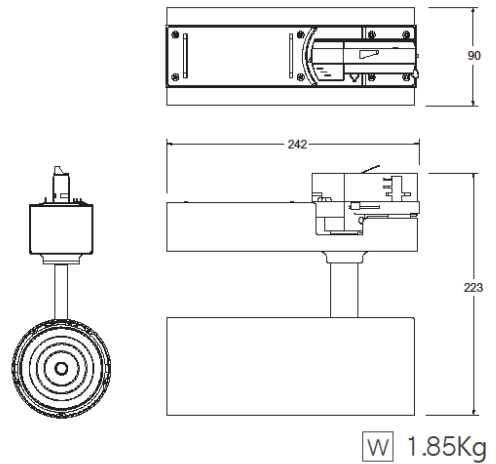

INSTALLATION INSTRUCTIONS

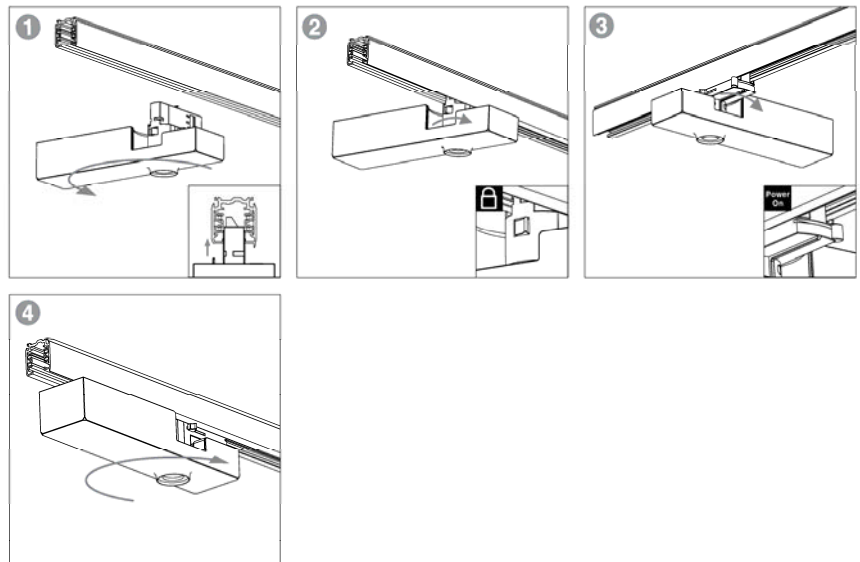

NOTES

Attention Read carefully before installing.
 The safety of this fixture is guaranteed only if you comply with these instructions. Save these instructions for future use.
 The operating temperature is between -20°C and +50°C.

INSTALLATION INSTRUCTIONS (Reflector)

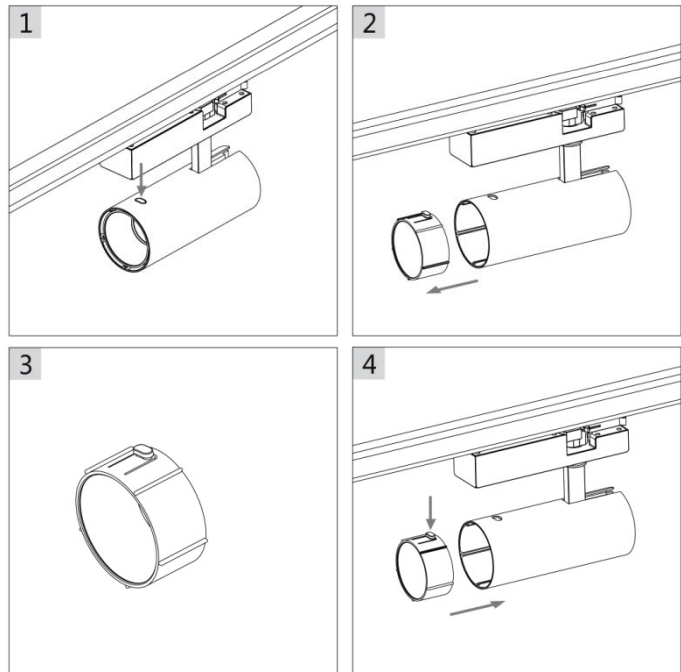

NOTES

Attention Read carefully before installing.

The safety of this fixture is guaranteed only if you comply with these instructions. Save these instructions for future use.

The operating temperature is between -20°C and +50°C.