

## FEATURES

Recessed LED single multi spot system, OM5 Trimless series.

### Housing

The integrated body structure provides strong heat dissipation.

### Reflector

NGR(Non Glare Reflector) Technology providing comfort and quality light to reduce stress.

Dust & Scratch proof reflector.

### Optic

20° or 30° beam angle available.



Product ordering number **11561B-827H-030-030**  
**11561B-830H-030-030**  
**11561B-840H-030-030**

## SPECIFICATIONS

INDEX		DATA
DIMENSION	mm	W259 X L161 X H132
WEIGHT	Kg	1.60
OPERATING VOLTAGE	V	AC 100~240V
POWER CONSUMPTION	W	32 (with power supply unit)
OUTPUT POWER	W	27
COLOR TEMPERATURE	K	2700 / 3000 / 4000
LUMINOUS FLUX	lm	2,700
LOR	-	0.83
COLOR RENDERING INDEX	Ra	Over 80
BEAM ANGLE	°	30
IP RATING	-	20
STORAGE HUMIDITY	%	20% ~ 70%
STORAGE TEMPERATURE	°C	-40°C ~ +50°C
OPERATING TEMPERATURE	°C	-20°C ~ +50°C

## SMPS

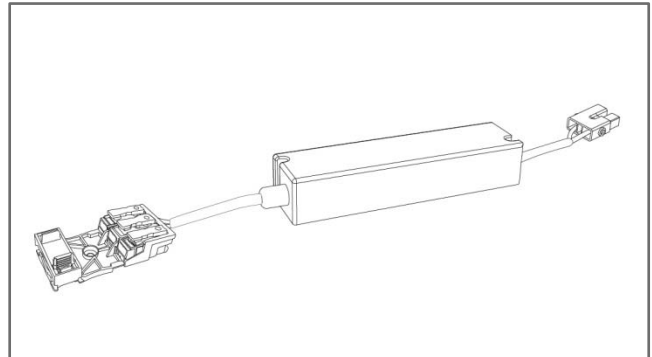

INDEX	ORDER NUMBER	NOTE
ON/OFF	80004	
1-10 Dimming	81005	
DALI Dimming	82003	
ON/OFF	80028	JAPAN
PWM Dimming	84007	JAPAN
DALI Dimming	82019	JAPAN
Triac Dimming	83013	AC 100~120V
Triac Dimming	83016	AC 220~240V

## PHOTOMETRIC DATA

30°		
m	Ø(m)	lux(center/side)
1	0.58	6450/3115
2	1.15	1612/778
3	1.73	717/346
4	2.30	403/195
5	2.88	258/125
6	3.45	179/86

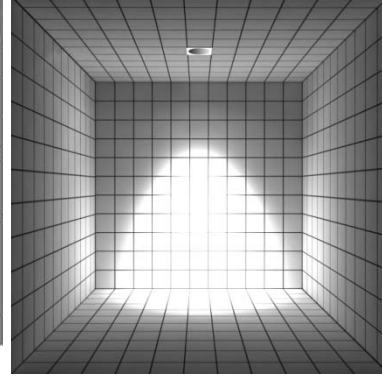
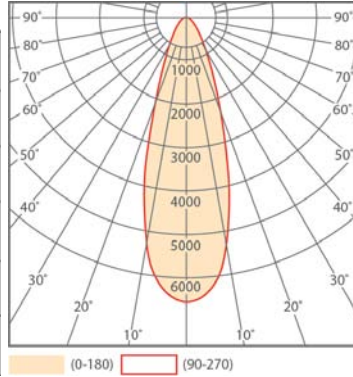

## DRAWING DATA

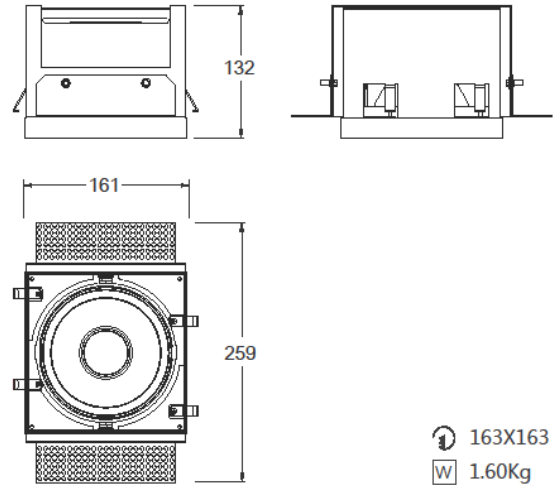

163X163  
W 1.60Kg

## INSTALLATION INSTRUCTIONS

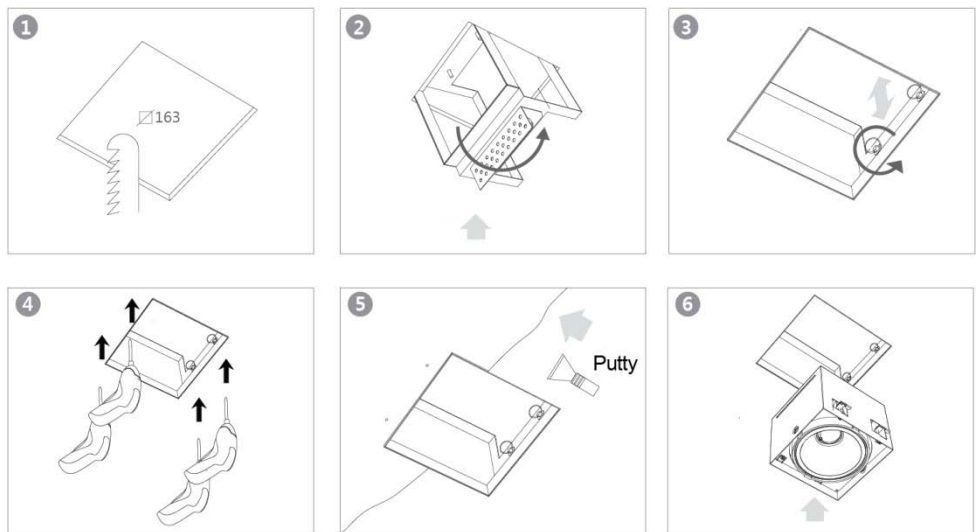

## NOTES

**Attention** Read carefully before installing.  
The safety of this fixture is guaranteed only if you comply with these instructions. Save these instructions for future use.  
The operating temperature is between -20°C and +50°C.