

# FlexElite IntelliHue

Date: \_\_\_\_\_  
Type: \_\_\_\_\_  
Firm Name: \_\_\_\_\_  
Project: \_\_\_\_\_

**20 Nodes, White Node/Cable,  
152 mm (6 in) On-Center Node  
Spacing**

## Exterior bright and beautiful flexible direct view luminaire with intelligent white and color light

FlexElite is the brightest and most flexible member of our popular Flex family, and it includes a redesign of all major elements, from its form factor to internal electronics to mechanical design. We created FlexElite to meet the challenges posed by large, unconventional buildings and structures. At its core, you'll find an innovative modular design that lets you create the exact number and configuration of nodes that you need for your design. FlexElite's sections and jumper cables click together quickly and easily, allowing unequalled customization impossible with less-modular solutions. Longer run lengths and node spacing let you take on larger challenges than possible in the past. FlexElite IntelliHue produces millions of saturated colors, pastels, and high-quality white light, in the same precisely controllable luminaire.

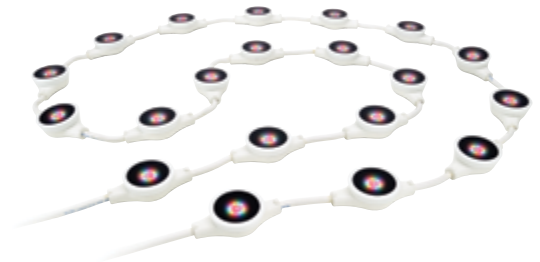

- **Modular Design**—FlexElite's advanced technology frees you from the limitations posed by static numbers of nodes on flexible cables—enabling longer run lengths and node spacing. You can choose sections with the number of nodes you need. Plus, multiple jumper cable lengths let you get the node spacing you need for your design—achieving the right resolution. FlexElite can deliver run lengths of up to 1,000 feet per run, with variable distances between nodes. With FlexElite, you can take on a wide range of outdoor applications, from arenas to office buildings to bridges.
- **Brighter Output**—FlexElite is the brightest Flex luminaire available, outputting over 100 lumens per node in RGBA versions, over 110 lumens per node in RGBW versions, and over 130 lumens per node in IntelliHue versions. At its brightest, FlexElite IntelliHue achieves 150 lumens per node. Brighter output lets you take on larger structures and create ambitious, large-scale designs that get noticed. And our lumen measurement complies with IES LM-79-08 testing procedures for consistency.
- **Four-Color Options**—FlexElite luminaires are natively designed as four-channel luminaires. Choose IntelliHue for the highest quality white light and dynamic color in the same luminaire. Choose RGBW or RGBA for deep color with white or amber. FlexElite includes our proprietary Chromasync technology for maximum color consistency.
- **Simple Installation**—Push-and-click connectors ensure reliable connections, while intuitive mounting options make it easy for installers to mount FlexElite on any structure.
- **Proven Reliability**—FlexElite is designed to be extremely reliable, year after year. Thanks to smart design, extensive testing, and years of experience, FlexElite can handle extreme conditions, humidity, heat, cold, and ice—delivering reliable performance.
- **Complete Solution**—An advanced, reliable luminaire is a critical part of your direct-view lighting solution, but it's not the only element that matters. That's why Color Kinetics offers a full range of complementary solutions—including power/data supplies, controllers, and much more. All designed and optimized to ensure seamless integration and years of trouble-free operation. For example, we designed our PDS-400 48V CA4 power/data supply specifically for FlexElite. And FlexElite integrates with ActiveSite, our remote monitoring solution.

For detailed product information, please refer to the Flex Family Product Guide at [www.colorkinetics.com/global/products/intellihue/flexelite-intellihue/](http://www.colorkinetics.com/global/products/intellihue/flexelite-intellihue/)

# Specifications

Due to continuous improvements and innovations, specifications may change without notice.

## Output

Viewing Angle	140°
Lumens Per Node (all channels full on) <sup>†</sup>	132
Lumens @ 2200 K	150
Lumens @ 2700 K	137
Lumens @ 3000 K	131
Lumens @ 3500 K	141
Lumens @ 4000 K	149
Lumens @ 5000 K	140
Lumens @ 5700 K	136
Lumens @ 6500 K	131
Luminance Per Node	111,353 cd/m <sup>2</sup>
On-Axis Candela per node	52
Efficacy (lm/W) per node all channels full on	52.8
CRI All Channels Full On	80
LED Channels	Red/Green/Royal Blue/Lime Green

## Electrical

Input Voltage	48 VDC via PDS-400 48V CA4
Power Consumption (Maximum per node at full output, steady state)	2.5 W

## Control

Interface	PDS-400 48V CA4
-----------	-----------------

### Control System

Color Kinetics full range of controllers, including Light System Manager, Video System Manager Pro, iPlayer 3, Antumbra iColor Keypad, and ColorDial Pro, or third-party controllers

Remote Monitoring & Management	ActiveSite Ready, works with Interact Landmark
--------------------------------	--

## Lumen Maintenance

Threshold <sup>§</sup>	Ambient Temperature	Reported <sup>¶</sup>	Calculated <sup>¶</sup>
L <sub>90</sub>	25 °C	> 42,000	44,802
	50 °C	35,439	35,439
L <sub>80</sub>	25 °C	> 42,000	> 100,000
	50 °C	> 42,000	80,740
L <sub>70</sub>	25 °C	> 42,000	> 100,000
	50 °C	> 42,000	> 100,000
L <sub>50</sub>	25 °C	> 42,000	> 100,000
	50 °C	> 42,000	> 100,000

<sup>†</sup> Lumen output measurements comply with IES LM-79-08 testing procedures.

<sup>§</sup> L<sub>xx</sub> = xx% lumen maintenance (when light output drops below xx% of initial output). All values are given at B10, or the median value where 90% of the LED population is better than the reported or calculated lumen maintenance measurement.

<sup>¶</sup> Lumen maintenance figures are based on lifetime prediction graphs supplied by LED source manufacturers. Whenever possible, figures use measurements that comply with IES LM-80-08 testing procedures. In accordance with TM-21-11, Reported values represent the interpolated value based on six times the LM-80-08 total test duration (in hours). Calculated values represent time durations that exceed six times the total test duration.

<sup>‡‡</sup> Due to voltage/power loss in leader and jumper cables, most installations will not be able to install the full 160 nodes per PDS. Please consult Color Kinetics for maximum run length calculations for your projects.

## Physical

Dimensions (Height x Width x Depth)	60 x 97.81 x 27.66 mm (2.36 x 3.85 x 1.09 in)
Weight	2.65 kg (5.84 lb)
Housing Material	White PBT plastic and powder-coated aluminium
Lens	Tempered glass
Luminaire Connections	Integrated watertight 5-pin connector

### Temperature Ranges

-40 to 50 °C (-40 to 122 °F) Operating  
 > 0 °C (> 32 °F) Handling  
 -20 to 50 °C (-4 to 122 °F) Startup  
 -40 to 80 °C (-40 to 176 °F) Storage

Humidity	0 to 95%, non-condensing
----------	--------------------------

### Maximum Luminaires Per Power/Data Supply<sup>‡‡</sup>

PDS-400 48V CA4: 160 nodes

## Certification and Safety

Approbation	UL/cUL, FCC Class A, CE
Environment	Dry/Damp/Wet Location, IP66



# Dimensions

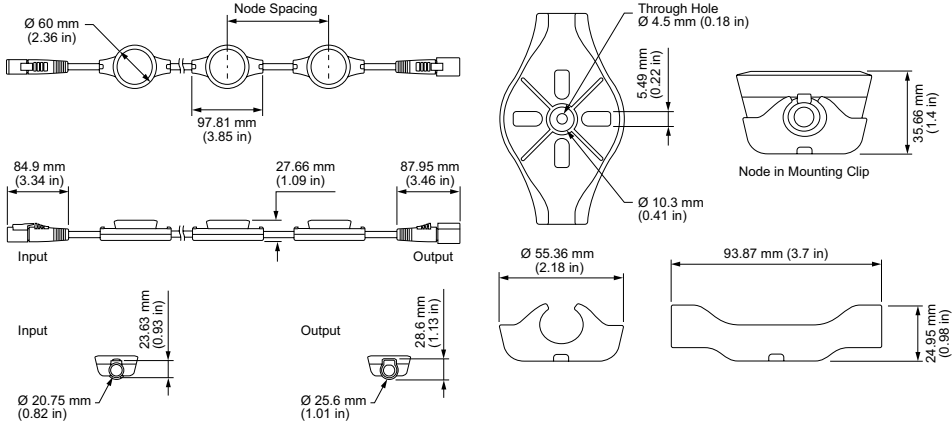

# Photometrics, all channels full on

Photometric data is based on test results from an independent NIST traceable testing lab. IES data is available at [www.colorkinetics.com/support/ies](http://www.colorkinetics.com/support/ies).

Viewing Angle	140°
LEDs	All channels full on
Lumens Per Node (all channels full on)	132
Efficacy (lm/W) per node all channels full on	52.8

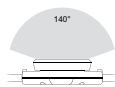

## Illuminance at Distance

	Center Beam fc	Beam Width
4 ft	3.28 fc	11.8 ft <b>11.8 ft</b>
8 ft	0.82 fc	23.6 ft <b>23.7 ft</b>
12 ft	0.36 fc	35.4 ft <b>35.5 ft</b>
16 ft	0.21 fc	47.2 ft <b>47.3 ft</b>
20 ft	0.13 fc	59.1 ft <b>59.1 ft</b>
24 ft	0.09 fc	70.9 ft <b>71 ft</b>

7.25 ft (2.2 m)  
 1 fc maximum distance  
 ■ Vert. Spread: 111.8°  
 ■ Horiz. Spread: 111.9°

## Polar Candela Distribution

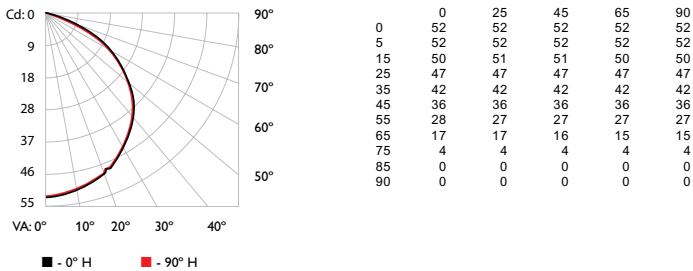

## Zonal Lumen

Zone	Lumens	% Luminaire
0-30	40.8	29.2%
0-40	67.2	48.0%
0-60	119.0	85.0%
60-90	21.0	15.0%
70-100	5.0	3.5%
90-120	0.0	0.0%
0-90	140.0	100.0%
90-180	0.0	0.0%
0-180	140.0	100.0%

For lux multiply fc by 10.7

## Coefficients of Utilization - Zonal Cavity Method

RCC %:	Effective Floor Cavity Reflectance: 20%																							
	80				70				50				30				10				0			
RW %:	70	50	30	0	70	50	30	0	50	30	20	0	50	30	20	0	50	30	20	0	50	30	20	0
0	1.19	1.19	1.19	1.19	1.16	1.16	1.16	1.16	1.11	1.11	1.11	1.11	1.06	1.06	1.06	1.06	1.02	1.02	1.02	1.02	1.02	1.02	1.02	1.02
1	1.1	1.06	1.02	0.99	1.07	1.04	1.01	1.07	0.99	0.97	0.94	0.94	0.96	0.93	0.91	0.91	0.92	0.9	0.88	0.86	0.86	0.86	0.86	0.86
2	1.01	0.93	0.87	0.82	0.98	0.91	0.85	0.74	0.88	0.83	0.79	0.79	0.84	0.8	0.77	0.77	0.82	0.78	0.75	0.73	0.73	0.73	0.73	0.73
3	0.92	0.82	0.74	0.68	0.9	0.81	0.73	0.64	0.78	0.72	0.67	0.67	0.75	0.7	0.65	0.65	0.72	0.68	0.64	0.62	0.62	0.62	0.62	0.62
4	0.84	0.73	0.65	0.58	0.82	0.72	0.64	0.55	0.69	0.62	0.57	0.57	0.67	0.61	0.56	0.56	0.65	0.6	0.55	0.53	0.53	0.53	0.53	0.53
5	0.78	0.65	0.57	0.5	0.76	0.64	0.56	0.48	0.62	0.55	0.49	0.49	0.6	0.54	0.49	0.49	0.58	0.53	0.48	0.46	0.46	0.46	0.46	0.46
6	0.72	0.59	0.5	0.44	0.7	0.58	0.5	0.42	0.56	0.49	0.43	0.43	0.54	0.48	0.43	0.43	0.53	0.47	0.42	0.4	0.4	0.4	0.4	0.4
7	0.66	0.53	0.45	0.39	0.65	0.52	0.44	0.38	0.51	0.44	0.38	0.38	0.49	0.43	0.38	0.38	0.48	0.42	0.38	0.36	0.36	0.36	0.36	0.36
8	0.62	0.49	0.4	0.34	0.6	0.48	0.4	0.34	0.47	0.39	0.34	0.34	0.45	0.39	0.34	0.34	0.44	0.38	0.34	0.32	0.32	0.32	0.32	0.32
9	0.58	0.45	0.36	0.31	0.56	0.44	0.36	0.3	0.43	0.36	0.31	0.31	0.42	0.35	0.31	0.31	0.41	0.35	0.3	0.29	0.29	0.29	0.29	0.29
10	0.54	0.41	0.33	0.28	0.53	0.41	0.33	0.28	0.4	0.33	0.28	0.28	0.39	0.32	0.28	0.28	0.38	0.32	0.28	0.26	0.26	0.26	0.26	0.26

# Luminaire and Accessories

Use Item Number when ordering in North America

Luminaire	Item Number	Item 12NC
FlexElite IntelliHue 20 Nodes, White Node/Cable, 152 mm (6 in) On-Center Node Spacing	401-000001-37	912400136372
<b>Accessories</b>		
FlexElite Leader Cable, 7.5 m (25 ft), White, UL/CE	108-000085-11	912400136431
FlexElite Leader Cable, 15 m (50 ft), White, UL/CE	108-000085-12	912400136432
FlexElite Leader Cable, 30 m (100 ft), White, UL/CE	108-000085-13	912400136433
FlexElite Leader Cable, 60 m (200 ft), White, UL/CE	108-000085-14	912400136434
FlexElite Jumper Cable, 305 mm (1 ft), White, UL/CE	108-000085-15	912400136435
FlexElite Jumper Cable, 500 mm (1.7 ft), White, UL/CE	108-000085-16	912400136436
FlexElite Jumper Cable, 610 mm (2 ft), White, UL/CE	108-000085-17	912400136437
FlexElite Jumper Cable, 1 m (3.3 ft), White, UL/CE	108-000085-18	912400136438
FlexElite Jumper Cable, 1.5 m (5 ft), White, UL/CE	108-000085-19	912400136439
FlexElite Jumper Cable, 2 m (6.6 ft), White, UL/CE	108-000085-20	912400136440
FlexElite Jumper Cable, 3 m (10 ft), White, UL/CE	108-000085-21	912400136441
FlexElite Dome Lens, White, 10 pieces	120-000204-03	912400136445
FlexElite Single Node Mounting Clip, White, 10 pieces	120-000204-01	912400136443
<b>Power Supplies</b>		
PDS-400 48V CA4, UL	109-000035-00	912400135914
PDS-400 48V CA4, CE	109-000035-01	912400136495



© 2019 Signify Holding. All rights reserved. Specifications are subject to change without notice. No representation or warranty as to the accuracy or completeness of the information included herein is given and any liability for any action in reliance thereon is disclaimed.

Color Kinetics  
[www.colorkinetics.com/global/products/intellihue/flexelite-intellihue/](http://www.colorkinetics.com/global/products/intellihue/flexelite-intellihue/)