

eColor Graze MX Powercore

Date: _____
Type: _____
Firm Name: _____
Project: _____

Green, 9° x 9° Beam Angle, 1219 mm
(4 ft)

Premium linear exterior LED wall grazing luminaires with solid color light

eColor Graze MX Powercore is a high-performance, exterior linear luminaire that features the most light output in our line of solid color LED grazing luminaires. It is designed to highlight architectural features with intensely saturated solid red, green, blue, or amber light. Multiple fixture lengths, beam angles, output levels, and power consumption levels support a large range of façade or surface illumination application. Low-profile housing, connectorized cabling, a universal power input range, and direct line voltage operation make Graze luminaires easy to install and operate.



- Tailor light output to specific applications—Available in four standard lengths (1 ft, 2 ft, 3 ft, and 4 ft), four performance levels (MX, QLX, QLX 5W, and EC), and six standard 9° x 9°, 10° x 60°, 15° x 30°, 30° x 60°, 60° x 30°, and 90° x 90° (EC only) beam angles.
- Flexible integration—Graze's ultra-low profile lets it fit discretely into almost any layout, from simple to elaborate.
- Customizable accessories - Customize your Graze fixture with a choice of three accessories: mounting arm, masking shield, and graze louver. Mounting arm available in three sizes and three colors (black, white, and gray), and masking shield available in four lengths (1 ft, 2 ft, 3 ft, and 4 ft).
- Integrates patented Powercore technology that controls power output to luminaires directly from line voltage – rapidly, efficiently, and accurately. The Color Kinetics Data Enabler Pro merges line voltage with control data and delivers them to luminaires over a single standard cable, dramatically simplifying installation and lowering total system cost.
- Graze provides years of reliable use under rugged conditions. Graze raises reliability even further with more protection from corrosion by meeting ASTM B117 standard and ANSI C136.31-2010 standard with a 3G vibration rating, and elimination of water pooling on the lens.
- Works seamlessly with the Color Kinetics full range of controllers, including Light System Manager, Video System Manager, Video System Manager Pro, iPlayer 3, Antumbra iColor Keypad, and ColorDial Pro—as well as third-party controllers.
- Convenient push-and-click connectors let you easily and rapidly install Leader Cables and Jumper Cables. Constant torque locking hinges offer simple and consistent position control from various angles.

For detailed product information, please refer to the eColor Graze MX Powercore Product Guide at www.colorkinetics.com/ls/essentialcolor/ecolorgrazemxpowercore/

Specifications

Due to continuous improvements and innovations, specifications may change without notice.

Output

Beam Angle	9° x 9°
Color	Green

Electrical

Input Voltage	100 to 277 VAC, auto-ranging, 50/60 Hz
Power Consumption (Maximum at full output, steady state)	60 W

For Surge Protection Requirements for LED Lighting Systems, please refer to www.colorkinetics.com/KB/surge-protection.

Control

Dimmer‡

Compatible with selected commercially available reverse-phase ELV-type dimmers

Physical

Dimensions (Height x Width x Depth)	69 x 1219 x 72 mm (2.7 x 48 x 2.85 in)
Weight	3.2 kg (9.3 lb)
Housing Material	Extruded anodized aluminium
Lens	Clear UV-protected polycarbonate
Luminaire Connections	Integral male/female waterproof connectors
Specs Mounting Title	Multi-positional, constant torque locking hinges

Temperature Ranges

-40 to 50 °C (-40 to 122 °F) Operating
-20 to 50 °C (-4 to 122 °F) Startup
-40 to 80 °C (-40 to 176 °F) Storage

Vibration Resistance

Not compliant to ANSI C136.31, 3G. Special orders are available to conform to the standard. Please contact your Color Kinetics Lighting Sales rep for custom configurations.

Mechanical Impact	IK10
-------------------	------

Corrosion Resistance

Complies with ASTM B117 standard with special order. Please contact your Color Kinetics Lighting Sales rep for custom configurations.

Humidity	0 to 95%, non-condensing
----------	--------------------------

Luminaire Run Lengths

To calculate luminaire run lengths and total power consumption for your specific installation, download the Configuration Calculator from www.colorkinetics.com/support/install_tool/

Certification and Safety

Approbation	UL/cUL, FCC Class A, CE, PSE, C-Tick
Environment	Dry/Damp/Wet Location, IP66



‡ Refer to www.colorkinetics.com/support/appnotes/ for more information.

Dimensions

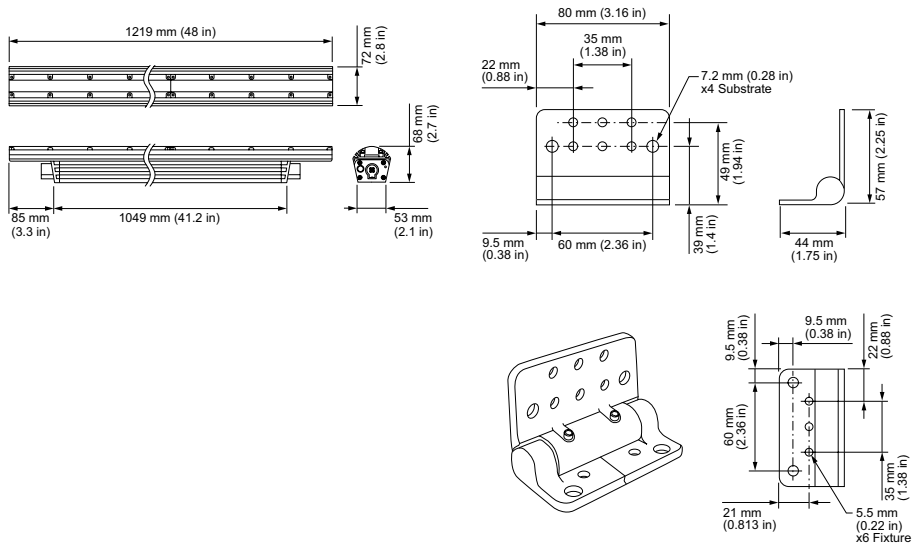

For help estimating the light output and distribution of eColor lighting luminaires, please contact Color Kinetics Applications Engineering Services at <http://www.lighting.philips.com/support/connect/contact-us>.

Luminaire and Accessories

Use Item Number when ordering in North America

Luminaire

	Item Number	Item 12NC
eColor Graze MX Powercore Green, 9° x 9° Beam Angle, 1219 mm (4 ft)	223-000080-61	910503703451

Accessories

Inground Enclosure, Outer Box for 1219 mm (4 ft) luminaire	120-000190-07	912400133691
Inground Enclosure, Inner Box for 1219 mm (4 ft) luminaire	120-000190-06	912400133690
Leader Cable with Terminator, UL/cUL, 3 m (10 ft)	108-000056-03	910503704071
Leader Cable with Terminator, UL/cUL, 15.2 m (50 ft)	108-000056-00	910503703138
Leader Cable with Terminator, CE/PSE, 3 m (10 ft)	108-000056-04	910503704072
Leader Cable with Terminator, CE/PSE, 15.2 m (50 ft)	108-000056-01	910503704069
Jumper Cable, UL/cUL, End-to-End	108-000057-00	910503703139
Jumper Cable, UL/cUL, 305 mm (1 ft)	108-000057-03	910503704076
Jumper Cable, UL/cUL, 1.5 m (5 ft)	108-000057-06	910503704079
Jumper Cable, UL/cUL, 3 m (10 ft)	108-000057-09	910503704082
Jumper Cable, CE/PSE, End-to-End	108-000057-01	910503704074
Jumper Cable, CE/PSE, 305 mm (1 ft)	108-000057-04	910503704077
Jumper Cable, CE/PSE, 1.5 m (5 ft)	108-000057-07	910503704080
Jumper Cable, CE/PSE, 3 m (10 ft)	108-000057-10	910503704083
Glare Shield, 1219 mm (4 ft)	120-000081-03	910503700748
Mounting Arm, Short, Gray	120-000201-03	912400135843
Mounting Arm, Medium, Gray	120-000201-04	912400135844
Mounting Arm, Long, Gray	120-000201-05	912400135845
Symmetric Louver, 1219 mm (48 in)	120-000202-03	912400135852
Masking Shield, 1219 mm (48 in)	120-000203-03	912400135860

