

eW Burst Powercore gen2

Date: _____
Type: _____
Firm Name: _____
Project: _____

**OptiField, 2700 K, Black Housing,
Landscape**

Exterior architectural and landscape spotlight OptiField luminaire with single temperature white light

eW Burst Powercore gen2, OptiField is a high output, exterior rated LED luminaire designed for accent and site lighting. eW Burst Powercore gen2, OptiField provides uniform lighting across large surfaces and increases application efficiency by directing more light on a specific target. Architectural and Landscape versions deliver high-quality white light output in a warm 2700 K and a neutral 4000 K to support a range of uplighting, floodlighting, and decorative lighting applications.



- Uniform illumination—eW Burst Powercore gen2, OptiField delivers a uniformity ratio of 3.8:1 on a 6.1 m (20 ft) wall with a 1 m (3 ft) setback.
- Precise control of light—Asymmetric optic design provides precise control of light and delivers more illumination with higher uniformity at a lower power than comparable fluorescent asymmetric reflector solutions.
- Design flexibility—eW Burst Powercore gen2, OptiField is designed to adapt to its surroundings regardless of the wall height, setback, or spacing of an installation.
- Expands customization with a wide range of new accessory options. Four housing color choices (black, gray, white, and bronze)—plus the option to add a trim ring or a half glare shield—create new aesthetic possibilities for designers and architects.
- Complies with ASTM B117 corrosion resistance standard for > 1,500 hours.
- Integrates patented Powercore technology that controls power output to luminaires directly from line voltage – rapidly, efficiently, and accurately. The Color Kinetics Data Enabler Pro merges line voltage with control data and delivers them to luminaires over a single standard cable, dramatically simplifying installation and lowering total system cost.
- Improves durability with new flat lens that prevents water from pooling into the luminaire, keeping the LEDs protected and secure over the course of a luminaire's lifetime.
- Universal power input range of 100 to 277 VAC.
- Digital Dimming—Smooth dimming down to 1% with optional Data Enabler Pro and digital control interface.

For detailed product information, please refer to the Burst Family Product Guide at www.colorkinetics.com/global/products/essentialwhite/ew-burst-powercore-gen2-fta/

Specifications

Due to continuous improvements and innovations, specifications may change without notice.

Output

Color Temperature*	2700 K
Lumens†	1,247
Efficacy (lm/W)	44.6
CRI	81

Electrical

Input Voltage	100 to 277 VAC, auto-ranging, 50/60 Hz
Power Consumption (Maximum at full output, steady state)	30 W
Power Factor	> 0.9 @ 100 to 240 VAC > 0.85 @ 277 VAC

For Surge Protection Requirements for LED Lighting Systems, please refer to www.colorkinetics.com/KB/surge-protection.

Control

Dimmer‡

ON/OFF; precision dimming by 4 conductor cable & Data Enabler Pro	
Remote Monitoring & Management	ActiveSite Ready, works with Interact Landmark

Lumen Maintenance

Threshold§	Ambient Temperature	Reported¶	Calculated¶
L ₉₀	25 °C	> 51,000	72,000
	50 °C	25,000	25,000
L ₈₀	25 °C		> 100,000
	50 °C	51,000	51,000
L ₇₀	25 °C	> 51,000	> 100,000
	50 °C	> 51,000	> 80,000

* Correlated color temperature (CCT) complies with ANSI C78.377-2008 for the chromaticity of solid state lighting products.

† Lumen output measurements comply with IES LM-79-08 testing procedures.

‡ Refer to www.colorkinetics.com/support/appnotes/ for more information.

§ L_{xx} = xx% lumen maintenance (when light output drops below xx% of initial output). All values are given at B10, or the median value where 90% of the LED population is better than the reported or calculated lumen maintenance measurement.

¶ Lumen maintenance figures are based on lifetime prediction graphs supplied by LED source manufacturers. Whenever possible, figures use measurements that comply with IES LM-80-08 testing procedures. In accordance with TM-21-11, Reported values represent the interpolated value based on six times the LM-80-08 total test duration (in hours). Calculated values represent time durations that exceed six times the total test duration.

Physical

Dimensions (Height x Width x Depth)	272 x 163 x 185 mm (10.7 x 6.42 x 7.28 in)
Weight	3.5 kg (7.7 lb)
Effective Projected Area (EPA)	0.026 m ² (0.28 ft ²) (Luminaire plus Full Glare Shield)
Housing Material	Die-cast aluminium, powder-coated finish
Lens	Clear tempered glass
Luminaire Connections	152 mm (6 in) flying leads

Temperature Ranges

-40 to 50 °C (-40 to 122 °F) Operating
-20 to 50 °C (-4 to 122 °F) Startup
-40 to 80 °C (-40 to 176 °F) Storage

Mechanical Impact	IK08
-------------------	------

Corrosion Resistance

Complies with ASTM B117 standard for > 1,500 hours

Humidity	0 to 95%, non-condensing
----------	--------------------------

Luminaire Run Lengths

To calculate luminaire run lengths and total power consumption for your specific installation, download the Configuration Calculator from www.colorkinetics.com/support/install_tool/

Certification and Safety

Approbation	UL/cUL, FCC Class A, CE, PSE, CQC, RCM
Environment	Dry/Damp/Wet Location, IP66



Dimensions

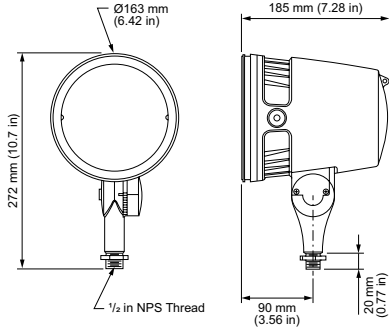

Photometrics, OptiField, 2700 K, all channels full on, native (no spread lens)

Photometric data is based on test results from an independent NIST traceable testing lab. IES data is available at www.colorkinetics.com/support/ies.

LEDs @	2700 K
Lumens	1,247
Efficacy (lm/W)	44.6
Target area uniformity	3.8:1

Polar Candela Distribution

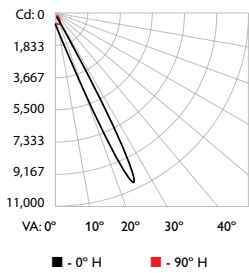

	0	22.5	45	67.5	90
0	611	611	611	611	611
5	878	849	780	696	612
15	2450	2175	1519	967	624
25	10707	6410	1666	721	494
35	96	139	167	84	149
45	50	43	31	26	24
55	22	18	18	17	14
65	21	12	11	13	10
75	21	5	5	7	5
85	1	1	1	3	1
90	0	2	1	1	1

Zonal Lumen

Zone	Lumens	% Luminaire
0-30	1,057.2	84.0%
0-40	1,182.8	94.0%
0-60	1,231.8	97.9%
60-90	19.8	1.6%
70-100	9.3	0.7%
90-120	2.4	0.2%
0-90	1,251.7	99.4%
90-180	7.0	0.6%
0-180	1,258.7	100.0%

For lux multiply fc by 10.7

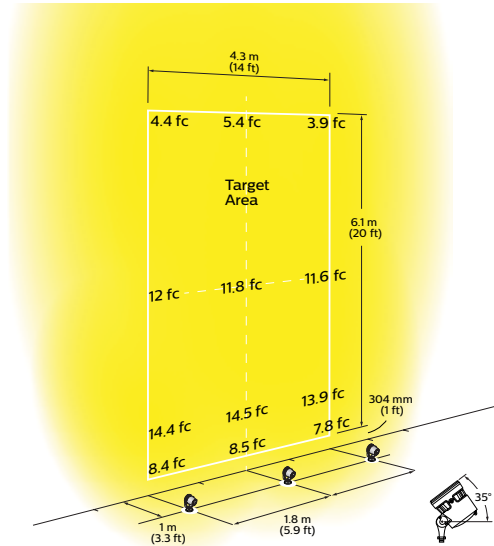

eW Burst Powercore gen4, OptiField Notes. Although this luminaire is designed to meet a large number of installation needs, specifically wall heights, we recommend using a measurement area like the example with a measurement grid of 610 mm (2 ft) or smaller. This approach will help you consistently create simulations that match mock-ups. In order to achieve the highest delivered illuminance and maximum level of uniformity, we recommend aiming the luminaire at a 35° rotation.

Luminaire and Accessories

Use Item Number when ordering in North America

Luminaire	Item Number	Item 12NC
eW Burst Powercore gen2 <i>OptiField, 2700 K, Black Housing, Landscape</i>	523-000101-03	912400135399
Accessories		
Trim Ring, Black	120-000189-21	912400135450
Half Glare Shield, Black	120-000189-25	912400135454
Wiring Compartment, 4 in diameter, Black, CE	106-000011-40	910503703275
Wiring Compartment, 4 in diameter, Black, UL	106-000011-30	910503704147
Power Supplies		
Data Enabler Pro, 3/4 in / 1/2 in NPT (U.S. trade size conduit)	106-000004-00	910503701210
Data Enabler Pro, PG21/PG13 (metric size conduit)	106-000004-01	910503701211



© 2019 Signify Holding. All rights reserved. Specifications are subject to change without notice. No representation or warranty as to the accuracy or completeness of the information included herein is given and any liability for any action in reliance thereon is disclaimed.

Color Kinetics
www.colorkinetics.com/global/products/essentialwhite/ew-burst-powercore-gen2-fta/