

ColorBurst IntelliHue Powercore

Date: _____
Type: _____
Firm Name: _____
Project: _____

**10° x 40° Asymmetric Spread Lens,
Black Housing, Architectural**

Architectural and landscape LED spotlight with intelligent white and color light

ColorBurst IntelliHue Powercore brings the precise control of color and high-quality tunable white light in the same luminaire for outdoor wall washing and spot lighting applications. The IntelliHue technology delivers 80+ CRI (2700 K to 4000 K) and the ability to tint any CCT between 2000 K and 10000 K above and below the black-body curve.



- Expands customization with a wide range of new accessory options. In addition to the native 8° lens, six different spread lenses can customize the luminaire to produce 10°, 20°, 40°, 60°, 80°, and 10° x 40° (asymmetric) beam angles. Four housing color choices (black, gray, white, and bronze)—plus the option to add a louver, full glare shield, and half glare shield—create new aesthetic possibilities for designers and architects.
 - Color-changing and high-quality white light from the same luminaire—IntelliHue is an advanced approach to color mixing that enables high-quality intelligent color and white light from a single luminaire. Multiple channels of LED light sources combine to produce a full spectrum of precisely controllable light, including millions of saturated colors, pastels, and uniform white light with CRI of greater than 83 in the 2700 K to 4000 K range.
 - Improves color consistency between all LED luminaires in a family with Chromasync technology. During the manufacturing process a calibrated light measurement device creates an algorithm to define a common color gamut for an entire family of LED luminaires. When Chromasync is enabled, color consistency between luminaires is achieved without having to manually adjust color points on each luminaire.
 - Complies with ASTM B117 corrosion resistance standard for > 1,500 hours and ANSI C136.31-2010 standard with a 3G vibration rating.
 - Delivers R9 values that can reach up to 77. Saturated red light gives objects and surfaces a vibrant and rich color that is ideal for spaces where ambience is important.
 - Features an innovative, redesigned optical system that improves the quality of light from each LED, enhancing the color uniformity and color mixing capabilities of each ColorBurst IntelliHue Powercore luminaire.
 - Improves durability with new flat lens that prevents water from pooling into the luminaire, keeping the LEDs protected and secure over the course of a luminaire's lifetime.
 - Integrates patented Powercore technology that controls power output to luminaires directly from line voltage – rapidly, efficiently, and accurately. The Color Kinetics Data Enabler Pro merges line voltage with control data and delivers them to luminaires over a single standard cable, dramatically simplifying installation and lowering total system cost.
 - Universal power input range of 100 to 277 VAC.
 - Works seamlessly with the complete Color Kinetics line of controllers, including ColorDial Pro, iPlayer 3, and Light System Manager – as well as third-party controllers.
- For detailed product information, please refer to the ColorBurst IntelliHue Powercore Product Guide at www.colorkinetics.com/global/products/intellihue/colorburst-powercore/

Specifications

Due to continuous improvements and innovations, specifications may change without notice.

Output

Beam Angle	10° x 40°
Lumens All Channels Full On†	1,281
Lumens @ 2700 K	911
Lumens @ 4000 K	930
Efficacy (lm/W) All Channels Full On	40.6
Efficacy (lm/W) @ 2700 K	49
Efficacy (lm/W) @ 4000 K	46.9
LED Channels	Red/Green/Blue/Mint White

Electrical

Input Voltage	100 to 277 VAC, auto-ranging, 50/60 Hz
Power Consumption (Maximum at full output, steady state)	33 W
Power Factor	> 0.9 @ 100 to 240 VAC > 0.85 @ 277 VAC

For Surge Protection Requirements for LED Lighting Systems, please refer to www.colorkinetics.com/KB/surge-protection.

Control

Interface	Data Enabler Pro (DMX/Ethernet)
-----------	---------------------------------

Control System

Color Kinetics full range of controllers, including Light System Manager, Video System Manager Pro, iPlayer 3, Antumbra iColor Keypad, and ColorDial Pro, or third-party controllers

Remote Monitoring & Management	ActiveSite Ready, works with Interact Landmark
--------------------------------	--

Lumen Maintenance

Threshold§	Ambient Temperature	Reported¶	Calculated¶
L ₉₀	25 °C	> 51,000	> 100,000
	50 °C	> 51,000	> 100,000
L ₈₀	25 °C	> 51,000	> 100,000
	50 °C	> 51,000	> 100,000
L ₇₀	25 °C	> 51,000	> 100,000
	50 °C	> 51,000	> 100,000
L ₅₀	25 °C	> 51,000	> 100,000
	50 °C	> 51,000	> 100,000

† Lumen measurement complies with IES LM-79-08 testing procedures.

§ L50 = 50% lumen maintenance (when light output drops below 50% of initial output). All values are given at B10, or the median value where 90% of the LED population is better than the reported or calculated lumen maintenance measurement.

¶ Lumen maintenance figures are based on lifetime prediction graphs supplied by LED source manufacturers. Whenever possible, figures use measurements that comply with IES LM-80-08 testing procedures. In accordance with TM-21-11, Reported values represent the interpolated value based on six times the LM-80-08 total test duration (in hours). Calculated values represent time durations that exceed six times the total test duration.

Physical

Dimensions (Height x Width x Depth)	287 x 210 x 186 mm (11.3 x 8.3 x 7.3 in)
Weight	5.5 kg (12.1 lb)
Effective Projected Area (EPA)	26053 mm ²
Housing Material	Die-cast aluminium, powder-coated finish
Lens	Clear tempered glass
Luminaire Connections	1.8 m (6 ft) combined power data whip

Temperature Ranges

-40 to 50 °C (-40 to 122 °F) Operating
-20 to 50 °C (-4 to 122 °F) Startup
-40 to 80 °C (-40 to 176 °F) Storage

Vibration Resistance

Complies with ANSI C136.31, 3G

Mechanical Impact	IK08
-------------------	------

Corrosion Resistance

Complies with ASTM B117 standard for > 1,500 hours

Humidity	0 to 95%, non-condensing
----------	--------------------------

Luminaire Run Lengths

To calculate luminaire run lengths and total power consumption for your specific installation, download the Configuration Calculator from www.colorkinetics.com/support/install_tool/

Certification and Safety

Approbation	UL/cUL, FCC Class A, CE, PSE, RCM
Environment	Dry/Damp/Wet Location, IP66



Dimensions

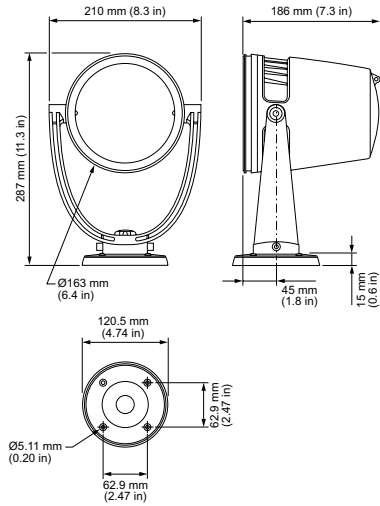

Photometrics, 10° x 40° asymmetric spread lens

Photometric data is based on test results from an independent NIST traceable testing lab. IES data is available at www.colorkinetics.com/support/ies.

Beam Angle	10° x 40°
LEDs	All channels full on
Lumens All Channels Full On	1,281
Efficacy (lm/W) All Channels Full On	40.6

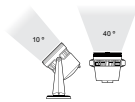

Illuminance at Distance

	Center Beam fc	Beam Width
4 ft	459.82 fc	0.7 ft 3.1 ft
8 ft	114.95 fc	1.4 ft 6.2 ft
12 ft	51.09 fc	2.2 ft 9.3 ft
16 ft	28.74 fc	2.9 ft 12.4 ft
20 ft	18.39 fc	3.6 ft 15.5 ft
24 ft	12.77 fc	4.3 ft 18.6 ft

85.8 ft (26.1 m)
1 fc maximum distance
Vert. Spread: 10.3°
Horiz. Spread: 42.4°

Polar Candela Distribution

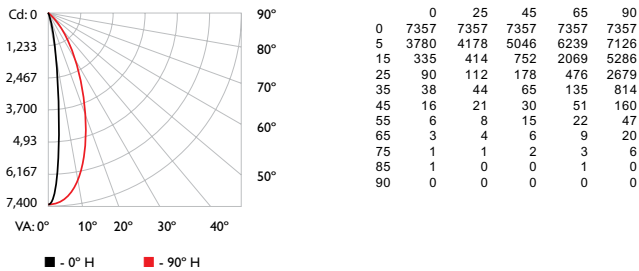

Coefficients of Utilization - Zonal Cavity Method

		Effective Floor Cavity Reflectance: 20%																								
RCC %:		80				70				50				30				10				0				
RW %:		70	50	30	0	70	50	30	0	50	30	20	0	50	30	20	0	50	30	20	0	50	30	20	0	
RCR:		0	1.19	1.19	1.19	1.16	1.16	1.16	1.00	1.11	1.11	1.11	1.06	1.06	1.06	1.02	1.02	1.02	1.00	1.02	1.01	1.00	0.99	0.98	0.97	0.96
1		1.15	1.12	1.10	1.08	1.12	1.10	1.08	0.96	1.06	1.05	1.03	1.02	1.01	1.00	0.99	0.98	0.97	0.96	0.96	0.95	0.94	0.93	0.93	0.91	
2		1.10	1.06	1.03	1.00	1.08	1.05	1.02	0.92	1.01	0.99	0.97	0.98	0.97	0.95	0.96	0.94	0.93	0.91	0.93	0.91	0.89	0.89	0.87	0.87	
3		1.06	1.01	0.97	0.94	1.04	1.00	0.96	0.88	0.97	0.94	0.92	0.95	0.92	0.90	0.93	0.91	0.89	0.87	0.90	0.87	0.85	0.84	0.84	0.84	
4		1.02	0.96	0.92	0.89	1.01	0.95	0.91	0.85	0.93	0.90	0.87	0.91	0.88	0.86	0.90	0.87	0.85	0.84	0.87	0.84	0.82	0.81	0.81	0.81	
5		0.99	0.92	0.88	0.84	0.97	0.91	0.87	0.81	0.90	0.86	0.83	0.88	0.85	0.82	0.87	0.84	0.82	0.81	0.84	0.81	0.79	0.78	0.78	0.78	
6		0.95	0.88	0.84	0.80	0.94	0.88	0.83	0.78	0.86	0.83	0.80	0.85	0.82	0.79	0.84	0.81	0.79	0.78	0.78	0.76	0.75	0.75	0.75	0.75	
7		0.92	0.85	0.80	0.77	0.91	0.85	0.80	0.76	0.83	0.79	0.77	0.82	0.79	0.76	0.81	0.78	0.76	0.75	0.75	0.73	0.72	0.72	0.72	0.72	
8		0.89	0.82	0.77	0.74	0.88	0.82	0.77	0.73	0.81	0.77	0.74	0.80	0.76	0.74	0.79	0.76	0.73	0.72	0.72	0.71	0.71	0.71	0.71	0.71	
9		0.87	0.79	0.75	0.72	0.86	0.79	0.75	0.71	0.78	0.74	0.71	0.77	0.74	0.71	0.77	0.73	0.71	0.70	0.70	0.69	0.69	0.69	0.69	0.69	
10		0.84	0.77	0.72	0.69	0.83	0.76	0.72	0.69	0.76	0.72	0.69	0.75	0.71	0.69	0.74	0.71	0.69	0.68	0.68	0.68	0.68	0.68	0.68	0.68	

Zonal Lumen

Zone	Lumens	% Luminaire
0-30	1115.0	87.0%
0-40	1217.5	95.0%
0-60	1270.5	99.2%
60-90	10.6	0.8%
70-100	3.2	0.3%
90-120	0.0	0.0%
0-90	1281.1	100.0%
90-180	0.0	0.0%
0-180	1281.1	100.0%

For lux multiply fc by 10.7

Photometrics, 2700 K

Photometric data is based on test results from an independent NIST traceable testing lab. IES data is available at www.colorkinetics.com/support/ies.

Beam Angle	10° x 40°
LEDs at	2700 K
Lumens @ 2700 K	911
Efficacy (lm/W) @ 2700 K	49

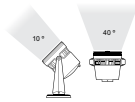

Illuminance at Distance

	Center Beam fc	Beam Width
4 ft	324.95 fc	0.8 ft 3 ft
8 ft	81.24 fc	1.6 ft 6 ft
12 ft	36.11 fc	2.4 ft 9 ft
16 ft	20.31 fc	3.2 ft 12 ft
20 ft	13 fc	4 ft 15 ft
24 ft	9.03 fc	4.8 ft 18 ft

72 ft (22 m)
1 fc maximum distance
Vert. Spread: 11.5°
Horiz. Spread: 41.1°

Polar Candela Distribution

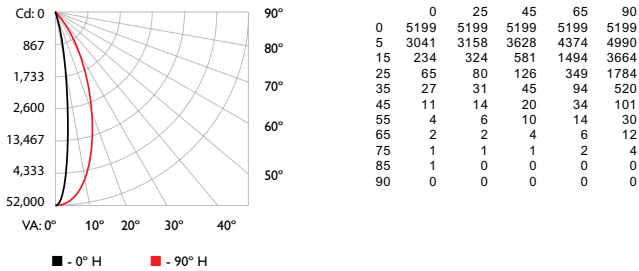

Zonal Lumen

Zone	Lumens	% Luminaire
0-30	796.7	87.4%
0-40	868.1	95.3%
0-60	903.9	99.2%
60-90	6.9	0.8%
70-100	2.2	0.2%
90-120	0.1	0.0%
0-90	910.8	100.0%
90-180	0.4	0.0%
0-180	911.2	100.0%

For lux multiply fc by 10.7

Coefficients of Utilization - Zonal Cavity Method

RCC %:	Effective Floor Cavity Reflectance: 20%																		
	80			70			50			30			10			0			
RW %:	70	50	30	0	70	50	30	0	50	30	20	50	30	20	0	50	30	20	0
RCR:	0	1.19	1.19	1.19	1.19	1.16	1.16	1.16	1.00	1.11	1.11	1.11	1.06	1.06	1.06	1.02	1.02	1.02	1.00
1	1.15	1.12	1.10	1.08	1.12	1.10	1.08	0.96	1.06	1.05	1.03	1.02	1.01	1.00	0.99	0.98	0.97	0.96	0.96
2	1.10	1.06	1.03	1.00	1.08	1.05	1.02	0.92	1.01	0.99	0.97	0.99	0.97	0.95	0.96	0.94	0.93	0.91	0.91
3	1.06	1.01	0.97	0.94	1.04	1.00	0.96	0.88	0.97	0.94	0.92	0.95	0.92	0.90	0.93	0.91	0.89	0.88	0.88
4	1.02	0.96	0.92	0.89	1.01	0.95	0.91	0.85	0.93	0.90	0.87	0.91	0.89	0.86	0.90	0.87	0.85	0.84	0.84
5	0.99	0.92	0.88	0.84	0.97	0.91	0.87	0.82	0.90	0.86	0.83	0.88	0.85	0.83	0.87	0.84	0.82	0.81	0.81
6	0.96	0.89	0.84	0.81	0.94	0.88	0.84	0.79	0.87	0.83	0.80	0.85	0.82	0.79	0.84	0.81	0.79	0.78	0.78
7	0.92	0.85	0.81	0.77	0.91	0.85	0.80	0.76	0.84	0.80	0.77	0.83	0.79	0.77	0.82	0.78	0.76	0.75	0.75
8	0.90	0.82	0.78	0.75	0.89	0.82	0.77	0.73	0.81	0.77	0.74	0.80	0.76	0.74	0.79	0.76	0.74	0.73	0.73
9	0.87	0.80	0.75	0.72	0.86	0.79	0.75	0.71	0.78	0.74	0.72	0.77	0.74	0.71	0.77	0.74	0.71	0.70	0.70
10	0.84	0.77	0.73	0.70	0.84	0.77	0.72	0.69	0.76	0.72	0.69	0.75	0.72	0.69	0.75	0.71	0.69	0.68	0.68

Photometrics, 4000 K

Photometric data is based on test results from an independent NIST traceable testing lab. IES data is available at www.colorkinetics.com/support/ies.

Beam Angle	10° x 40°
LEDs at	4000 K
Lumens @ 4000 K	930
Efficacy (lm/W) @ 4000 K	46.9

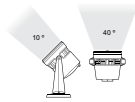

Illuminance at Distance

	Center Beam fc	Beam Width
4 ft	334.02 fc	0.8 ft 3 ft
8 ft	83.50 fc	1.5 ft 6.1 ft
12 ft	37.11 fc	2.3 ft 9.1 ft
16 ft	20.88 fc	3.1 ft 12.1 ft
20 ft	13.36 fc	3.9 ft 15.2 ft
24 ft	9.28 fc	4.6 ft 18.2 ft

73 ft (22.2 m)
1 fc maximum distance
Vert. Spread: 11°
Horiz. Spread: 41.5°

Polar Candela Distribution

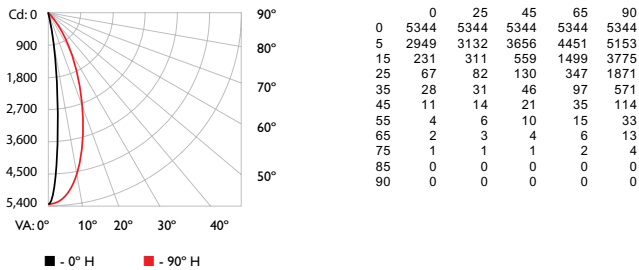

Zonal Lumen

Zone	Lumens	% Luminaire
0-30	810.4	87.1%
0-40	884.5	95.1%
0-60	922.2	99.1%
60-90	7.5	0.8%
70-100	2.4	0.3%
90-120	0.1	0.0%
0-90	929.7	99.9%
90-180	0.5	0.1%
0-180	930.1	100.0%

For lux multiply fc by 10.7

Coefficients of Utilization - Zonal Cavity Method

RCC %:	Effective Floor Cavity Reflectance: 20%																		
	80			70			50			30			10			0			
RW %:	70	50	30	0	70	50	30	0	50	30	20	50	30	20	0	50	30	20	0
RCR:	0	1.19	1.19	1.19	1.16	1.16	1.16	1.00	1.11	1.11	1.11	1.06	1.06	1.06	1.02	1.02	1.02	1.00	1.00
1	1.15	1.12	1.10	1.08	1.12	1.10	1.08	0.96	1.06	1.05	1.03	1.02	1.01	1.00	0.99	0.98	0.97	0.96	0.96
2	1.10	1.06	1.03	1.00	1.08	1.05	1.02	0.92	1.01	0.99	0.97	0.98	0.97	0.95	0.96	0.94	0.93	0.91	0.91
3	1.06	1.01	0.97	0.94	1.04	1.00	0.96	0.88	0.97	0.94	0.92	0.95	0.92	0.90	0.93	0.91	0.89	0.88	0.88
4	1.02	0.96	0.92	0.89	1.01	0.95	0.91	0.85	0.93	0.90	0.87	0.91	0.88	0.86	0.90	0.87	0.85	0.84	0.84
5	0.99	0.92	0.88	0.84	0.97	0.91	0.87	0.81	0.90	0.86	0.83	0.88	0.85	0.82	0.87	0.84	0.82	0.81	0.81
6	0.95	0.89	0.84	0.81	0.94	0.88	0.83	0.78	0.86	0.83	0.80	0.85	0.82	0.79	0.84	0.81	0.79	0.78	0.78
7	0.92	0.85	0.81	0.77	0.91	0.85	0.80	0.76	0.83	0.80	0.77	0.82	0.79	0.76	0.81	0.78	0.76	0.75	0.75
8	0.89	0.82	0.78	0.74	0.88	0.82	0.77	0.73	0.81	0.77	0.74	0.80	0.76	0.74	0.79	0.76	0.73	0.72	0.72
9	0.87	0.79	0.75	0.72	0.86	0.79	0.75	0.71	0.78	0.74	0.71	0.77	0.74	0.71	0.77	0.73	0.71	0.70	0.70
10	0.84	0.77	0.72	0.69	0.83	0.76	0.72	0.69	0.76	0.72	0.69	0.75	0.71	0.69	0.74	0.71	0.69	0.68	0.68

Luminaire and Accessories

Use Item Number when ordering in North America

Luminaire

	Item Number	Item 12NC
ColorBurst IntelliHue Powercore <i>Black Housing, Architectural Luminaire only. Values in this specification sheet represent both the luminaire and spread lens combined. Spread lens available below in Associated Part.</i>	423-000003-24	912400135472

Associated Part

10°x40° Spread Lens <i>Trim Ring or Glare Shield required for mounting. Must be ordered separately.</i>	120-000189-16	912400133446
--	---------------	--------------

Accessories

Trim Ring gen2, Black	120-000189-21	912400135450
Half Glare Shield gen2, Black	120-000189-25	912400135454
Full Glare Shield gen2, Black	120-000189-29	912400135458
Louver	120-000189-17	912400133447
Mounting Arm, Short, Black	120-000201-00	912400135840
Mounting Arm, Medium, Black	120-000201-01	912400135841
Mounting Arm, Long, Black	120-000201-02	912400135842
Wiring Compartment, 4 in diameter, Black, CE	106-000011-40	910503703275
Wiring Compartment, 4 in diameter, Black, UL	106-000011-30	910503704147

Power/Data Supplies

Data Enabler Pro, 3/4 in / 1/2 in NPT (U.S. trade size conduit)	106-000004-00	910503701210
Data Enabler Pro, PG21/PG13 (metric size conduit)	106-000004-01	910503701211

