

iColor Flex LMX gen2

Date: _____
Type: _____
Firm Name: _____
Project: _____

Narrow Beam Lens, Black Housing,
12 in On-Center Node Spacing

Flexible strands of high-intensity LED nodes with intelligent color light

iColor Flex LMX gen2 are flexible strands of large, high-intensity, full-color LED nodes designed for extraordinary effects and expansive installations without the constraints of luminaire size, shape, or space. Each iColor Flex LMX gen2 strand consists of 50 individually addressable LED nodes, featuring dynamic integration of power, communication, and control. The flexible form factor accommodates two- and three-dimensional configurations, while high light output affords superior long-distance viewing for architectural accent and perimeter lighting, large-scale signage, and building-covering video displays.



- Multiple lens options—Clear flat, translucent dome, and narrow beam lenses are standard. Optional marquee lenses, available in clear, semi-frosted, and translucent, snap onto flat-lens nodes to create the appearance of bulbs on a traditional theatre marquee. You can mount marquee lenses in front of a substrate or directly to mounted strands.
- Adaptable mounting—iColor Flex LMX gen2 strands can be mounted directly to a surface like traditional string lights. Detachable leader cables in multiple lengths allow you to install strings at the appropriate distance from power/data supplies. Optional mounting tracks ensure straight linear runs, while snap-on spacers hide cabling and mounting hardware between nodes for a clean, finished look. Single node mounts can be positioned individually to provide anchor points for installations with uneven node spacing or complex geometries. Optional glare shields can block unwanted spill light or prevent light sources from being visible in certain applications.
- Standard and custom lengths and node spacing—Standard on-center node spacing of 102 mm (4 in) or 305 mm (12 in) and custom spacing from 76 mm (3 in) to 610 mm (24 in) support virtually any lighting or video design. Standard 50-node strands can be field-shortened. Custom lengths of 1 to 60 nodes are also available. For information about custom orders, see the iColor Flex LMX gen2 Ordering Sheet at www.colorkinetics.com/ls/rgb/flexlmx/.
- Custom Leader Cables—Custom Leader Cable lengths are available in addition to standard cables of 7.6 m (25 ft), 15.2 m (50 ft), and 30.5 m (100 ft).
- Industry-leading controls—iColor Flex LMX gen2 works seamlessly with the Color Kinetics full range of controllers, including Light System Manager, Video System Manager Pro, iPlayer 3, Antumbra iColor Keypad, and ColorDial Pro, or third-party controllers.
- Outdoor rated—Fully sealed for maximum node life and IP66-rated for outdoor applications.
- Daylight visible—iColor Flex LMX gen2 strands consist of 50 large, individually controllable, high-intensity LED nodes. Each node produces full-color light output of up to 28.7 candela.

For detailed product information, please refer to the iColor Flex LMX gen2 Product Guide at www.colorkinetics.com/ls/rgb/flexlmx/

Specifications

Due to continuous improvements and innovations, specifications may change without notice.

Output

Color Temperature	2700 K
Viewing Angle	36°
Lumens Per Node†	28
Luminance Per Node	41,949 cd/m ²
On-Axis Candela per node	28.7
Efficacy (lm/W) per node	27.9
LED Channels	Red/Green/Blue

Electrical

Input Voltage	24 VDC via PDS-60ca 24V, sPDS-60ca 24V, sPDS-480ca 24V, or CM-150 CA 24V
Power Consumption	1 W

(Maximum per node at full output, steady state)

Control

Interface	PDS-60ca 24V (Pre-programmed, or DMX/Ethernet) sPDS-60ca 24V (DMX/Ethernet) sPDS-480ca 24V (Ethernet) CM-150 CA (DIN Rail or Surface Mount)
-----------	--

Control System

Color Kinetics full range of controllers, including Light System Manager, Video System Manager Pro, iPlayer 3, Antumbra iColor Keypad, and ColorDial Pro, or third-party controllers

Remote Monitoring & Management	ActiveSite Ready, works with Interact Landmark
--------------------------------	--

Lumen Maintenance

Threshold§	Ambient Temperature	Reported¶	Calculated¶
L ₇₀	25 °C	60,000	100,000
	50 °C	60,000	100,000
L ₅₀	25 °C	60,000	100,000
	50 °C	60,000	100,000

† Lumen measurement complies with IES LM-79-08 testing procedures.

§ L_{xx} = xx% lumen maintenance (when light output drops below xx% of initial output). All values are given at B10, or the median value where 90% of the LED population is better than the reported or calculated lumen maintenance measurement.

¶ Lumen maintenance figures are based on lifetime prediction graphs supplied by LED source manufacturers. Whenever possible, figures use measurements that comply with IES LM-80-08 testing procedures. In accordance with TM-21-11, Reported values represent the interpolated value based on six times the LM-80-08 total test duration (in hours). Calculated values represent time durations that exceed six times the total test duration.

Physical

Dimensions (Height x Width x Depth)	31 x 32 x 27 mm (1.2 x 1.3 x 1.1 in)
Weight	1.74 kg (3.84 lb) ^{50 nodes}
Housing Material	Black polycarbonate
Lens	Translucent UV-protected polycarbonate
Luminaire Connections	Integrated watertight 3-pin connector

Temperature Ranges

-40 to 50 °C (-40 to 122 °F) Operating
> 0 °C (> 32 °F) Handling
-20 to 50 °C (-4 to 122 °F) Startup
-40 to 80 °C (-40 to 176 °F) Storage

Humidity	0 to 95%, non-condensing
----------	--------------------------

Maximum Luminaires Per Power/Data Supply

sPDS-480ca 24V: 8 strands
sPDS-60ca 24V: 1 strand
PDS-60ca 24V: 1 strand
CM-150 CA: 2 strands

Certification and Safety

Approbation	UL/cUL, FCC Class A, CE
Environment	Dry/Damp/Wet Location, IP66



Dimensions

Narrow Beam Lens

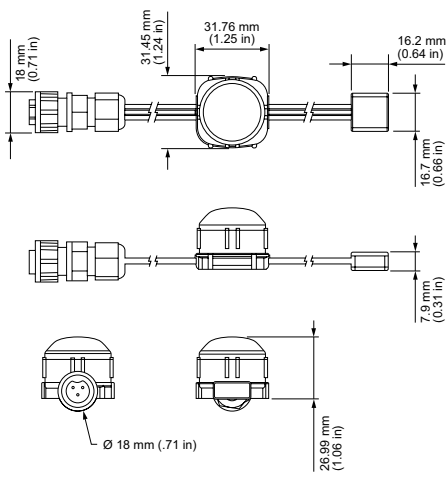

Single Node Mount

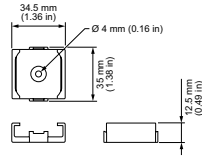

Spacer

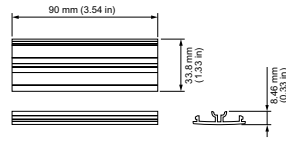

Mounting Track

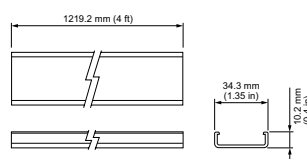

Photometrics, narrow beam lens

Photometric data is based on test results from an independent NIST traceable testing lab. IES data is available at www.colorkinetics.com/support/ies.

Viewing Angle	36°
LED	RGB
Lumens Per Node	28
Efficacy (lm/W) per node	27.9

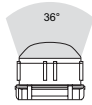

Illuminance at Distance

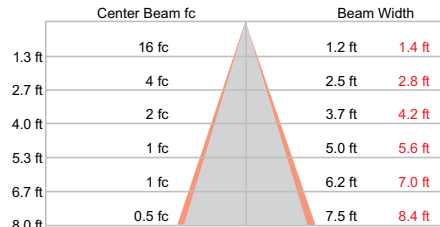

1.6 m (5.3 ft)
1 fc maximum distance
Vert. Spread: 49.9°
Horiz. Spread: 55.1°

Polar Candela Distribution

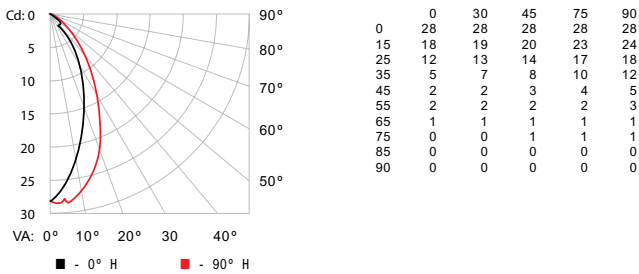

Coefficients of Utilization - Zonal Cavity Method

RCC %:	Effective Floor Cavity Reflectance: 20%																		
	80			70			50			30			10			0			
RW %:	70	50	30	0	70	50	30	0	50	30	20	50	30	20	0				
RCR:	0	1.18	1.18	1.18	1.18	1.15	1.15	1.15	0.97	1.09	1.09	1.09	1.04	1.04	1.04	0.99	0.99	0.99	0.97
	1	1.11	1.07	1.04	1.01	1.08	1.05	1.02	0.88	1.00	0.98	0.96	0.96	0.94	0.92	0.92	0.91	0.89	0.87
	2	1.04	0.98	0.92	0.88	1.01	0.96	0.91	0.79	0.92	0.88	0.85	0.88	0.85	0.82	0.85	0.82	0.80	0.78
	3	0.97	0.89	0.83	0.78	0.95	0.87	0.82	0.72	0.84	0.79	0.76	0.81	0.77	0.74	0.79	0.75	0.72	0.71
	4	0.91	0.82	0.75	0.70	0.89	0.80	0.74	0.65	0.78	0.72	0.68	0.75	0.71	0.67	0.73	0.69	0.66	0.64
	5	0.86	0.76	0.69	0.63	0.84	0.74	0.68	0.60	0.72	0.67	0.62	0.70	0.65	0.61	0.68	0.64	0.60	0.59
	6	0.81	0.70	0.63	0.58	0.79	0.69	0.63	0.55	0.67	0.61	0.57	0.65	0.60	0.56	0.64	0.59	0.56	0.54
	7	0.76	0.65	0.58	0.53	0.74	0.64	0.58	0.51	0.63	0.57	0.53	0.61	0.56	0.52	0.60	0.55	0.52	0.50
	8	0.72	0.61	0.54	0.49	0.70	0.60	0.54	0.48	0.59	0.53	0.49	0.58	0.52	0.48	0.56	0.52	0.48	0.46
	9	0.68	0.57	0.51	0.46	0.67	0.57	0.50	0.45	0.55	0.50	0.46	0.54	0.49	0.45	0.53	0.48	0.45	0.43
	10	0.65	0.54	0.47	0.43	0.64	0.53	0.47	0.42	0.52	0.47	0.43	0.51	0.46	0.42	0.50	0.46	0.42	0.41

Zonal Lumen

Zone	Lumens	% Luminaire
0-30	15.1	54.1%
0-40	20.2	72.6%
0-60	24.6	88.4%
60-90	2.4	8.7%
70-100	1.1	4.0%
90-120	0.4	1.6%
0-90	27.1	97.0%
90-180	0.8	3.0%
0-180	27.9	100.0%

For lux multiply fc by 10.7

Luminaire and Accessories

Use Item Number when ordering in North America

Luminaire

	Item Number	Item 12NC
iColor Flex LMX gen2 <i>Narrow Beam Lens, Black housing, 12 in on-center node spacing 50 node strand</i>	101-000077-10	912400135779

Accessories

Leader Cable, 7.6 m (25 ft), Black (for use with Power/Data Supplies)	108-000045-00	910503700696
Leader Cable, 15.2 m (50 ft), Black (for use with Power/Data Supplies)	108-000045-01	910503700697
Leader Cable, 30.5 m (100 ft), Black (for use with Power/Data Supplies)	108-000045-02	910503700698
Leader Cable, 4-Wire, 15.2 m (50 ft) (for use with CM-150 CA Item # 109-000033-00)	108-000080-01	912400135907
Leader Cable, 4-Wire, 30.5 m (100 ft) (for use with CM-150 CA Item # 109-000033-00)	108-000080-02	912400135908
Leader Cable, 3-Wire, 305 mm (1 ft) (for use with CM-150 CA Item # 109-000033-02)	108-000081-01	912400136051
Leader Cable, 3-Wire, 7.6 m (25 ft) (for use with CM-150 CA Item # 109-000033-02)	108-000081-00	912400135909
Leader Cable, 4-Wire, 15.2 m (50 ft) (for use with CM-150 CA Item # 109-000034-00)	108-000082-01	912400135910
Leader Cable, 4-Wire, 30.5 m (100 ft) (for use with CM-150 CA Item # 109-000034-00)	108-000082-02	912400135911
Leader Cable, 3-Wire, 7.6 m (25 ft) (for use with CM_150CA Item # 109-000034-02)	108-000083-00	912400135912
Mounting Track, 1.2 m (4 ft), Black	101-000057-01	910503700045
Spacers, Qty 50, 305 mm (12 in), Black	101-000061-01	910503700053
Single-Node Mounts, Qty 50, Black	101-000058-01	910503700047

Power Supplies

PDS-60ca 24V, Power/Data Supply, Pre-programmed	109-000016-00	910503700095
PDS-60ca 24V, Power/Data Supply, DMX/Ethernet	109-000016-04	912400133526
sPDS-60ca 24V Power/Data Supply, DMX/Ethernet (NA Power Cord)	109-000021-04	912400133527
sPDS-60ca 24V Power/Data Supply, DMX/Ethernet (EU/UK Power Cord)	109-000021-05	912400133636
sPDS-480ca 24V, Power/Data Supply, Ethernet	109-000026-01	912400133528
CM-150 CA, DIN Rail Mount, Four-Wire Terminal, 24V	109-000033-00	912400135766
CM-150 CA, DIN Rail Mount, Three-Wire Terminal, 24V	109-000033-02	912400135768
CM-150 CA, Surface Mount (IP66), Four-Wire Terminal, 24V	109-000034-00	912400135770
CM-150 CA, Surface Mount (IP66), Three-Wire Terminal, 24V	109-000034-02	912400135772



© 2018 Signify Holding. All rights reserved. Specifications are subject to change without notice. No representation or warranty as to the accuracy or completeness of the information included herein is given and any liability for any action in reliance thereon is disclaimed.

Color Kinetics
www.colorkinetics.com/ls/rgb/flexlhx/