

ColorBurst IntelliHue Powercore

Date: _____
Type: _____
Firm Name: _____
Project: _____

**80° Spread Lens, Gray Housing,
Architectural**

Architectural and landscape LED spotlight with intelligent white and color light

ColorBurst IntelliHue Powercore brings the precise control of color and high-quality tunable white light in the same luminaire for outdoor wall washing and spot lighting applications. The IntelliHue technology delivers 80+ CRI (2700 K to 4000 K) and the ability to tint any CCT between 2000 K and 10000 K above and below the black-body curve.



- Expands customization with a wide range of new accessory options. In addition to the native 8° lens, six different spread lenses can customize the luminaire to produce 10°, 20°, 40°, 60°, 80°, and 10° x 40° (asymmetric) beam angles. Four housing color choices (black, gray, white, and bronze)—plus the option to add a louver, full glare shield, and half glare shield—create new aesthetic possibilities for designers and architects.
 - Color-changing and high-quality white light from the same luminaire—IntelliHue is an advanced approach to color mixing that enables high-quality intelligent color and white light from a single luminaire. Multiple channels of LED light sources combine to produce a full spectrum of precisely controllable light, including millions of saturated colors, pastels, and uniform white light with CRI of greater than 83 in the 2700 K to 4000 K range.
 - Improves color consistency between all LED luminaires in a family with Chromasync technology. During the manufacturing process a calibrated light measurement device creates an algorithm to define a common color gamut for an entire family of LED luminaires. When Chromasync is enabled, color consistency between luminaires is achieved without having to manually adjust color points on each luminaire.
 - Complies with ASTM B117 corrosion resistance standard for > 1,500 hours and ANSI C136.31-2010 standard with a 3G vibration rating.
 - Delivers R9 values that can reach up to 77. Saturated red light gives objects and surfaces a vibrant and rich color that is ideal for spaces where ambience is important.
 - Features an innovative, redesigned optical system that improves the quality of light from each LED, enhancing the color uniformity and color mixing capabilities of each ColorBurst IntelliHue Powercore luminaire.
 - Improves durability with new flat lens that prevents water from pooling into the luminaire, keeping the LEDs protected and secure over the course of a luminaire's lifetime.
 - Integrates patented Powercore technology that controls power output to luminaires directly from line voltage – rapidly, efficiently, and accurately. The Color Kinetics Data Enabler Pro merges line voltage with control data and delivers them to luminaires over a single standard cable, dramatically simplifying installation and lowering total system cost.
 - Universal power input range of 100 to 277 VAC.
 - Works seamlessly with the complete Color Kinetics line of controllers, including ColorDial Pro, iPlayer 3, and Light System Manager – as well as third-party controllers.
- For detailed product information, please refer to the ColorBurst IntelliHue Powercore Product Guide at www.colorkinetics.com/global/products/intellihue/colorburst-powercore/

Specifications

Due to continuous improvements and innovations, specifications may change without notice.

Output

Beam Angle	80°
Lumens All Channels Full On†	1,248
Lumens @ 2700 K	897
Lumens @ 4000 K	935
Efficacy (lm/W) All Channels Full On	40
Efficacy (lm/W) @ 2700 K	48.3
Efficacy (lm/W) @ 4000 K	47.2
LED Channels	Red/Green/Blue/Mint White

Electrical

Input Voltage	100 to 277 VAC, auto-ranging, 50/60 Hz
Power Consumption (Maximum at full output, steady state)	33 W
Power Factor	> 0.9 @ 100 to 240 VAC > 0.85 @ 277 VAC

For Surge Protection Requirements for LED Lighting Systems, please refer to www.colorkinetics.com/KB/surge-protection.

Control

Interface	Data Enabler Pro (DMX/Ethernet)
-----------	---------------------------------

Control System

Color Kinetics full range of controllers, including Light System Manager, Video System Manager Pro, iPlayer 3, Antumbra iColor Keypad, and ColorDial Pro, or third-party controllers

Remote Monitoring & Management	ActiveSite Ready, works with Interact Landmark
--------------------------------	--

Lumen Maintenance

Threshold§	Ambient Temperature	Reported¶	Calculated¶
L ₉₀	25 °C	> 51,000	> 100,000
	50 °C	> 51,000	> 100,000
L ₈₀	25 °C	> 51,000	> 100,000
	50 °C	> 51,000	> 100,000
L ₇₀	25 °C	> 51,000	> 100,000
	50 °C	> 51,000	> 100,000
L ₅₀	25 °C	> 51,000	> 100,000
	50 °C	> 51,000	> 100,000

† Lumen measurement complies with IES LM-79-08 testing procedures.

§ L50 = 50% lumen maintenance (when light output drops below 50% of initial output). All values are given at B10, or the median value where 90% of the LED population is better than the reported or calculated lumen maintenance measurement.

¶ Lumen maintenance figures are based on lifetime prediction graphs supplied by LED source manufacturers. Whenever possible, figures use measurements that comply with IES LM-80-08 testing procedures. In accordance with TM-21-11, Reported values represent the interpolated value based on six times the LM-80-08 total test duration (in hours). Calculated values represent time durations that exceed six times the total test duration.

Physical

Dimensions (Height x Width x Depth)	287 x 210 x 186 mm (11.3 x 8.3 x 7.3 in)
Weight	5.5 kg (12.1 lb)
Effective Projected Area (EPA)	26053 mm ²
Housing Material	Die-cast aluminium, powder-coated finish
Lens	Clear tempered glass
Luminaire Connections	1.8 m (6 ft) combined power data whip

Temperature Ranges

-40 to 50 °C (-40 to 122 °F) Operating
 -20 to 50 °C (-4 to 122 °F) Startup
 -40 to 80 °C (-40 to 176 °F) Storage

Vibration Resistance

Complies with ANSI C136.31, 3G

Mechanical Impact	IK08
-------------------	------

Corrosion Resistance

Complies with ASTM B117 standard for > 1,500 hours

Humidity	0 to 95%, non-condensing
----------	--------------------------

Luminaire Run Lengths

To calculate luminaire run lengths and total power consumption for your specific installation, download the Configuration Calculator from www.colorkinetics.com/support/install_tool/

Certification and Safety

Approbation	UL/cUL, FCC Class A, CE, PSE, RCM
Environment	Dry/Damp/Wet Location, IP66



Dimensions

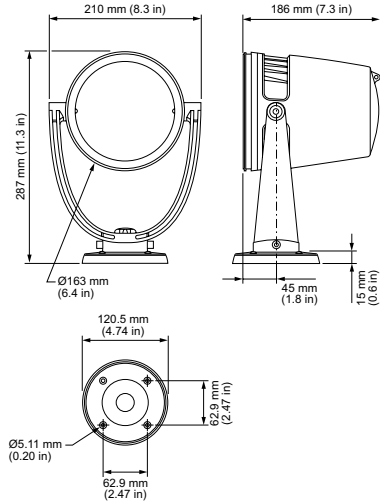

Photometrics, 80° spread lens

Photometric data is based on test results from an independent NIST traceable testing lab. IES data is available at www.colorkinetics.com/support/ies.

Beam Angle	80°
LEDs	All channels full on
Lumens All Channels Full On	1,248
Efficacy (lm/W) All Channels Full On	40

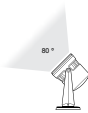

Polar Candela Distribution

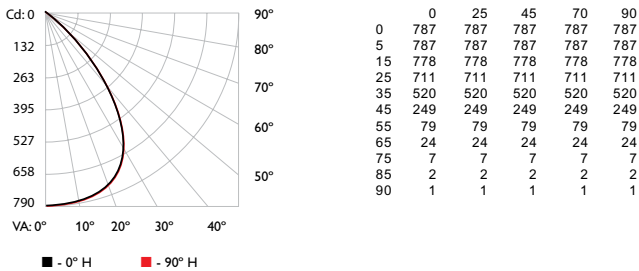

Zonal Lumen

Zone	Lumens	% Luminaire
0-30	619.3	49.6%
0-40	940.5	75.4%
0-60	1,211.8	97.1%
0-90	1,247.1	100.0%
60-90	35.3	2.8%
70-100	11.2	0.9%
90-120	0.6	0.0%
90-180	0.6	0.0%
0-180	1,247.7	100.0%

For lux multiply fc by 10.7

Illuminance at Distance

	Center Beam fc	Beam Width
4 ft	49 fc	6.6 ft 6.7 ft
8 ft	12 fc	13.3 ft 13.3 ft
12 ft	5 fc	19.9 ft 20.0 ft
16 ft	3 fc	26.6 ft 26.6 ft
20 ft	2 fc	33.2 ft 33.3 ft
24 ft	1 fc	39.8 ft 39.9 ft

28 ft (8.5 m)
 1 fc maximum distance
 ■ Vert. Spread: 79.4°
 ■ Horiz. Spread: 79.5°

Coefficients of Utilization - Zonal Cavity Method

RCC %:	Effective Floor Cavity Reflectance: 20%																							
	80				70				50				30				10				0			
RW %:	70	50	30	0	70	50	30	0	50	30	20	0	50	30	20	0	50	30	20	0	50	30	20	0
0	1.19	1.19	1.19	1.19	1.16	1.16	1.16	1.00	1.11	1.11	1.11	1.06	1.06	1.06	1.06	1.02	1.02	1.02	1.02	1.00	1.02	1.02	1.02	1.00
1	1.12	1.09	1.06	1.03	1.10	1.07	1.04	0.92	1.03	1.01	0.99	0.99	0.97	0.97	0.96	0.95	0.94	0.94	0.93	0.91	0.95	0.94	0.93	0.91
2	1.05	0.99	0.95	0.91	1.03	0.98	0.93	0.83	0.94	0.91	0.88	0.91	0.88	0.86	0.86	0.88	0.86	0.86	0.84	0.82	0.88	0.86	0.84	0.82
3	0.99	0.91	0.85	0.80	0.96	0.89	0.84	0.75	0.87	0.82	0.78	0.84	0.80	0.77	0.77	0.82	0.78	0.78	0.76	0.74	0.82	0.78	0.76	0.74
4	0.92	0.83	0.77	0.72	0.90	0.82	0.76	0.68	0.80	0.74	0.70	0.78	0.73	0.69	0.69	0.76	0.72	0.72	0.68	0.67	0.76	0.72	0.68	0.67
5	0.86	0.78	0.69	0.64	0.85	0.75	0.69	0.62	0.73	0.68	0.63	0.72	0.67	0.63	0.63	0.70	0.66	0.66	0.62	0.60	0.70	0.66	0.62	0.60
6	0.81	0.70	0.63	0.58	0.79	0.70	0.63	0.56	0.68	0.62	0.58	0.66	0.61	0.57	0.57	0.65	0.60	0.60	0.57	0.55	0.65	0.60	0.57	0.55
7	0.76	0.65	0.58	0.53	0.75	0.64	0.58	0.52	0.63	0.57	0.52	0.62	0.56	0.52	0.52	0.60	0.56	0.56	0.52	0.50	0.60	0.56	0.52	0.50
8	0.71	0.60	0.53	0.48	0.70	0.60	0.53	0.47	0.58	0.52	0.48	0.57	0.52	0.48	0.48	0.56	0.51	0.51	0.48	0.46	0.56	0.51	0.48	0.46
9	0.67	0.56	0.49	0.45	0.66	0.56	0.49	0.44	0.54	0.48	0.44	0.54	0.48	0.44	0.44	0.53	0.48	0.48	0.44	0.42	0.53	0.48	0.44	0.42
10	0.64	0.52	0.46	0.41	0.62	0.52	0.45	0.41	0.51	0.45	0.41	0.50	0.45	0.41	0.41	0.49	0.44	0.44	0.41	0.39	0.49	0.44	0.41	0.39

Photometrics, 2700 K

Photometric data is based on test results from an independent NIST traceable testing lab. IES data is available at www.colorkinetics.com/support/ies.

Beam Angle	80°
LEDs at	2700 K
Lumens @ 2700 K	897
Efficacy (lm/W) @ 2700 K	48.3

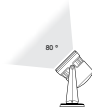

Polar Candela Distribution

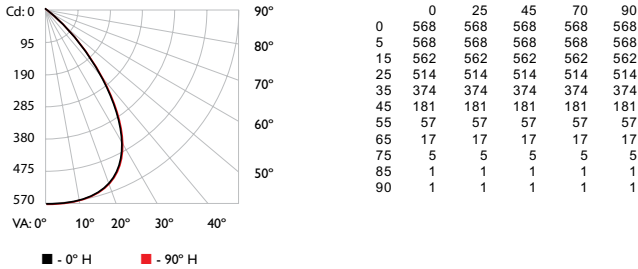

Zonal Lumen

Zone	Lumens	% Luminaire
0-30	447.5	49.9%
0-40	678.3	75.6%
0-60	872.4	97.2%
0-90	897.0	99.9%
60-90	24.5	2.7%
70-100	7.3	0.8%
90-120	0.3	0.0%
90-180	0.5	0.1%
0-180	897.5	100.0%

For lux multiply fc by 10.7

Illuminance at Distance

	Center Beam fc	Beam Width
4 ft	36 fc	6.6 ft
8 ft	9 fc	13.2 ft
12 ft	4 fc	19.8 ft
16 ft	2 fc	26.5 ft
20 ft	1 fc	33.1 ft
24 ft	1 fc	39.7 ft

23.8 ft (7.3 m)
1 fc maximum distance
Vert. Spread: 79.2°
Horiz. Spread: 79.2°

Coefficients of Utilization - Zonal Cavity Method

RCC %:	Effective Floor Cavity Reflectance: 20%														
	80			70			50			30			10		
RW %:	70	50	30	0	70	50	30	0	50	30	20	50	30	20	0
RCR:	0	1.19	1.19	1.19	1.16	1.16	1.16	1.00	1.11	1.11	1.11	1.06	1.06	1.06	1.02
1	1.12	1.09	1.06	1.03	1.10	1.07	1.04	0.92	1.03	1.01	0.99	0.99	0.97	0.96	0.95
2	1.05	1.00	0.95	0.91	1.03	0.98	0.93	0.83	0.94	0.91	0.88	0.91	0.88	0.86	0.89
3	0.99	0.91	0.85	0.80	0.96	0.89	0.84	0.75	0.87	0.82	0.78	0.84	0.80	0.77	0.82
4	0.92	0.83	0.77	0.72	0.90	0.82	0.76	0.68	0.80	0.74	0.70	0.78	0.73	0.69	0.76
5	0.86	0.77	0.70	0.64	0.85	0.75	0.69	0.62	0.74	0.68	0.63	0.72	0.67	0.63	0.70
6	0.81	0.70	0.63	0.58	0.79	0.70	0.63	0.57	0.68	0.62	0.58	0.66	0.61	0.57	0.65
7	0.76	0.65	0.58	0.53	0.75	0.64	0.58	0.52	0.63	0.57	0.53	0.62	0.56	0.52	0.60
8	0.72	0.60	0.53	0.49	0.70	0.60	0.53	0.48	0.59	0.53	0.48	0.57	0.52	0.48	0.56
9	0.67	0.56	0.49	0.45	0.66	0.56	0.49	0.44	0.55	0.49	0.44	0.54	0.48	0.44	0.53
10	0.64	0.52	0.46	0.41	0.62	0.52	0.45	0.41	0.51	0.45	0.41	0.50	0.45	0.41	0.49

Photometrics, 4000 K

Photometric data is based on test results from an independent NIST traceable testing lab. IES data is available at www.colorkinetics.com/support/ies.

Beam Angle	80°
LEDs at	4000 K
Lumens @ 4000 K	935
Efficacy (lm/W) @ 4000 K	47.2

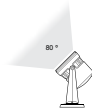

Polar Candela Distribution

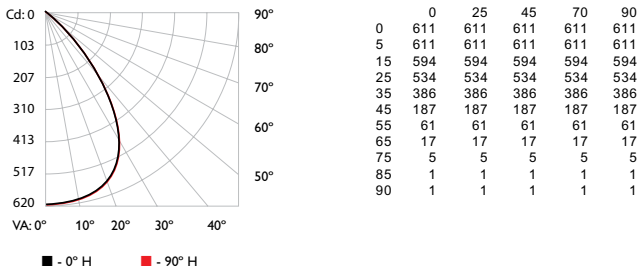

Zonal Lumen

Zone	Lumens	% Luminaire
0-30	469.7	50.2%
0-40	707.8	75.7%
0-60	908.2	97.2%
0-90	934.1	99.9%
60-90	25.9	2.8%
70-100	8.1	0.9%
90-120	0.4	0.0%
90-180	0.6	0.1%
0-180	934.7	100.0%

For lux multiply fc by 10.7

Illuminance at Distance

	Center Beam fc	Beam Width
4 ft	38 fc	6.5 ft
8 ft	10 fc	12.9 ft
12 ft	4 fc	19.4 ft
16 ft	2 fc	25.8 ft
20 ft	2 fc	32.3 ft
24 ft	1 fc	38.7 ft

24.7 ft (7.5 m)
1 fc maximum distance
Vert. Spread: 77.8°
Horiz. Spread: 77.9°

Coefficients of Utilization - Zonal Cavity Method

RCC %:	Effective Floor Cavity Reflectance: 20%														
	80			70			50			30			10		
RW %:	70	50	30	0	70	50	30	0	50	30	20	50	30	20	0
RCR:	0	1.19	1.19	1.19	1.16	1.16	1.16	1.00	1.11	1.11	1.11	1.06	1.06	1.06	1.02
1	1.12	1.09	1.06	1.03	1.10	1.07	1.04	0.92	1.03	1.01	0.99	0.99	0.97	0.96	0.95
2	1.05	1.00	0.95	0.91	1.03	0.98	0.93	0.83	0.94	0.91	0.88	0.91	0.88	0.86	0.89
3	0.99	0.91	0.85	0.80	0.97	0.90	0.84	0.75	0.87	0.82	0.78	0.84	0.80	0.77	0.82
4	0.92	0.83	0.77	0.72	0.90	0.82	0.76	0.68	0.80	0.74	0.70	0.78	0.73	0.69	0.76
5	0.87	0.77	0.70	0.65	0.85	0.75	0.69	0.62	0.74	0.68	0.63	0.72	0.67	0.63	0.70
6	0.81	0.71	0.64	0.58	0.80	0.70	0.63	0.57	0.68	0.62	0.58	0.67	0.61	0.57	0.65
7	0.76	0.65	0.58	0.53	0.75	0.65	0.58	0.52	0.63	0.57	0.53	0.62	0.56	0.52	0.60
8	0.72	0.61	0.54	0.49	0.70	0.60	0.53	0.48	0.59	0.53	0.48	0.57	0.52	0.48	0.56
9	0.68	0.56	0.49	0.45	0.66	0.56	0.49	0.44	0.55	0.49	0.45	0.54	0.48	0.44	0.53
10	0.64	0.53	0.46	0.41	0.63	0.52	0.46	0.41	0.51	0.45	0.41	0.50	0.45	0.41	0.49

Luminaire and Accessories

Use Item Number when ordering in North America

Luminaire	Item Number	Item 12NC
ColorBurst IntelliHue Powercore <i>Gray Housing, Architectural Luminaire only. Values in this specification sheet represent both the luminaire and spread lens combined. Spread lens available below in Associated Part.</i>	423-000003-21	912400135470
Associated Part		
80° Spread Lens <i>Trim Ring or Glare Shield required for mounting. Must be ordered separately.</i>	120-000189-15	912400133445
Accessories		
Trim Ring gen2, Gray	120-000189-20	912400135449
Half Glare Shield gen2, Gray	120-000189-24	912400135453
Full Glare Shield gen2, Gray	120-000189-28	912400135457
Louver	120-000189-17	912400133447
Mounting Arm, Short, Gray	120-000201-03	912400135843
Mounting Arm, Medium, Gray	120-000201-04	912400135844
Mounting Arm, Long, Gray	120-000201-05	912400135845
Wiring Compartment, 4 in diameter, Gray, CE	106-000011-42	910503703277
Wiring Compartment, 4 in diameter, Gray, UL	106-000011-32	910503704149
Power/Data Supplies		
Data Enabler Pro, 3/4 in / 1/2 in NPT (U.S. trade size conduit)	106-000004-00	910503701210
Data Enabler Pro, PG21/PG13 (metric size conduit)	106-000004-01	910503701211



© 2019 Signify Holding. All rights reserved. Specifications are subject to change without notice. No representation or warranty as to the accuracy or completeness of the information included herein is given and any liability for any action in reliance thereon is disclaimed.

Color Kinetics
www.colorkinetics.com/global/products/intellihue/colorburst-powercore/